

SHARP

Be Original.

AR-7024

Digital Multifunction System

**A Reliable 3-in-1 Solution
to Meet Your Growing
Document Demands**



The Overall Multifunctional Efficiency Your Office Needs

This versatile monochrome MFP is a smart all-in-one document solution for the upwardly mobile small business. Naturally, it excels in its core role of copying, printing, and scanning documents with text and images. But beyond that, it offers flexibility in the form of upgradeable hardware and software. The MFP is designed to put sophisticated document functionality in the hands of every office user. End result: greater productivity for you and your team.



DOCUMENT WORKFLOW

Convenient Full-Colour Scanning

This MFP works as a full-colour A3 scanner. In addition to scanning via a TWAIN driver, the MFP has a Button Manager function. As well as letting you adjust settings such as scan resolution, this function allows you to assign applications such as e-mail, Microsoft® Word, and OCR to six Scan Menu buttons on the MFP's control panel. Scanning, data transfer, and application start-up can all be done automatically. Operation is quick and easy—simply tap the Scan Mode button, select a pre-registered Scan Menu button, and press Start.

Example of Assigning Buttons When Upgraded to Full-Colour Network Scanning

Adding the optional AR-NB8 Network Expansion Kit upgrades the MFP to a full-colour network scanner, enhancing its scan functionality.



Button 1-3 Scan to E-mail A/B/C

Scanned files can be sent as an attachment to any e-mail address over the Internet.

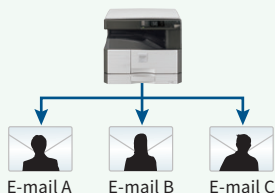

Button 5 Scan to USB Drive

Scanned files can be stored directly on a USB drive.



Button 4 Scan to FTP Server

Scanned files can be stored on a file server where they can be easily accessed from any PC on the network.



Button 6 Scan to Desktop*1 or Mobile Device*2

Scanned files can be forwarded directly to your PC or a mobile device.

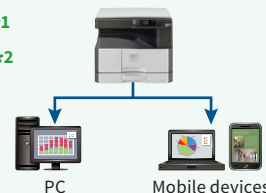

Note: Buttons 1–6 must be assigned a scan destination in advance. Scan to Desktop and Scan to Mobile Device can be assigned to Button 6 only. Choose which one you would like to assign.
 *1: PC must have Network Scanner Tool Lite installed. *2: Mobile device must have Sharpdesk Mobile app installed.

3-in-1 PERFORMANCE

Super-Efficient Output

This MFP delivers a fast output of 24 ppm*. The first copy comes out in just 6.4 seconds for A4 and 6.5 seconds for 8 1/2" x 11", saving valuable time when you're doing multiple short-run jobs.

*A4 (8 1/2" x 11"), long-edge feeding



Automatic Document Feeding

An optional RSPF (reversing single pass feeder) efficiently feeds in up to 100 sheets of either one- or two-sided originals.

Effective Paper Handling

For large-volume jobs and a wider selection of available paper sizes, the MFP can accommodate two types of extra trays that increase total paper capacity to 1,850 sheets. The MFP can accommodate heavy paper up to 200 g/m²*, expanding the range of possible printing applications.

*106–200 g/m² paper to be fed through multi-bypass tray.

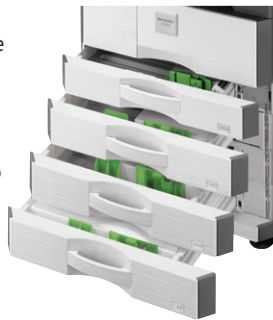

Rotation Sort*

Every other copy is rotated 90 degrees when delivered to the output tray. This takes the hassle out of sorting copies and comes in handy when you need to print multiple copies.

*Two paper trays must be loaded with the same-sized paper in a different orientation (landscape and portrait).



Printing with Sharp Technology

The MFP incorporates Sharp's original SPLC (Sharp Printer Language with Compression) printing technology. SPLC effectively reduces the data size of a print job, speeding up data transfer and printing while improving overall throughput.

Network Printing

The optional AR-NB8 Network Expansion Kit upgrades the MFP to a network printer. Add the optional AR-PB10 Printer Expansion Kit for PCL 6 emulation. The further addition of the optional MX-PK10 PS Expansion Kit allows the MFP to support PostScript® 3™ emulation, giving you increased font compatibility and better graphics handling.

ID Card Copy

The MFP has a dedicated key for easy copying of both sides of a card (e.g., an ID or credit card) onto a single page.

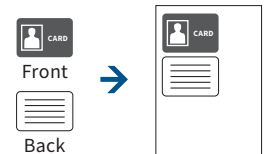

2-in-1/4-in-1 Copying

Reduce paper use by copying two or four separate pages onto a single sheet. It's convenient, space-saving, and eco-friendly all at once.



Other Convenient Features

- Margin shift
- Edge/centre erase

OTHER KEY FEATURES

Sharpdesk Mobile*

Sharpdesk Mobile is a mobile print/scan application. With Sharpdesk Mobile, users can import documents scanned on the MFP to their mobile devices for previewing and saving. And files on a mobile device can be printed out on the MFP, sent as e-mail attachments, or used in other applications.

*Requires a third-party wireless LAN router and optional AR-NB8; PDF printing additionally requires optional MX-PK10. Availability varies by country/region. For details, see the support website: https://global.sharp/products/copier/docu_solutions/mobile/sharpdesk_mobile/

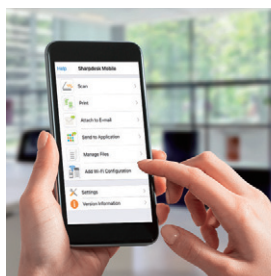

Network Scanner Tool Lite*

This software makes it easy to scan documents with the MFP and save them in designated folders on your PC, without the need for complicated settings.

*Requires optional AR-NB8.

Device Management

Sharp Remote Device Manager* (SRDM) allows admins to remotely monitor the status of consumables in the MFP, so you can easily check for things like empty paper trays or low toner levels.

*Requires optional AR-NB8. Contact a Sharp customer representative for availability and other details.

LED Status Lamps

Next to the control panel are two LED lamps: one red, one green. These light up to notify you—even from a distance—of the status of the machine.

Easy-Grip Handles

Easy-grip handles on the MFP reflect a universal design that allows the paper drawers to be grasped from the top as well as the bottom for easy opening and closing.

Energy Efficiency

Pressing the power save key after a job is finished immediately puts the MFP into auto power shut-off mode, further reducing your running costs.

SPECIFICATIONS

General

| | |
|---------------------------------------|--|
| Type | Desktop |
| Engine speed | A4 (8 1/2" x 11")*1: Max. 24 ppm A3 (11" x 17"): Max. 12 (11) ppm |
| Control panel display | Custom LCD |
| Paper size | Max. A3 (11" x 17"), min. A6*2 (5 1/2" x 8 1/2") |
| Paper capacity (80 g/m ²) | Standard: 350 sheets (250-sheet tray and 100-sheet multi-bypass tray) Maximum: 1,850 sheets (350 sheets & optional 500-sheet tray x 3) |
| Paper weight | Tray: 55 g/m ² to 105 g/m ² (13 lbs bond to 28 lbs bond) Multi-bypass tray: 55 g/m ² to 200 g/m ² (13 lbs bond to 110 lbs index) |
| Warm-up time*3 | 25 sec. |
| Memory | Standard: 64 MB Maximum: 448 MB*4 |
| Power requirements | Rated local AC voltage ±10%, 50/60 Hz |
| Power consumption | Max. 1.2 kW |
| Dimensions (W x D x H) | 599 x 612 x 511 mm (23 13/32" x 24 7/64" x 20 1/8") |
| Weight (approx.) | 28 kg (61.8 lbs) |

Colour Scanner

| | |
|-------------------|---|
| Resolution | Push scan: 75, 100, 150, 200, 300, 400, 600 dpi Pull scan: 75, 100, 150, 200, 300, 400, 600 dpi; 50 dpi to 9,600 dpi via user setting*7 |
| File formats | TIFF, PDF, JPEG*8, BMP*9 |
| Scan destinations | Scan to e-mail*10/desktop*11/FTP server*10/USB drive*10 |

Printer

| | |
|----------------------|--|
| Resolution | 600 x 600 dpi |
| Interface | USB 2.0 (host, high-speed), 10Base-T*10/100Base-TX*10 |
| Supported OS*12 | Windows Server® 2012, Windows Server® 2012 R2, Windows Server® 2016, Windows Server® 2019, Windows® 8.1, Windows® 10, Mac OS 10.9, 10.10, 10.11, 10.12, 10.13, 10.14, 10.15 |
| Network protocols*10 | TCP/IP |
| PDL | SPLC (Sharp Printer Language with Compression), PCL 6 emulation*13, PostScript® 3™ emulation*14 |
| Available fonts | 80 fonts for PCL*13, 136 fonts for PostScript 3 emulation*14 |

Copier

| | |
|----------------------|---|
| Original paper size | Max. A3 (11" x 17") |
| First copy time*5 | A4: 6.4 seconds 8 1/2" x 11": 6.5 seconds |
| Continuous copy | Max. 999 copies |
| Resolution | 600 x 600 dpi |
| Gradation | 256 levels |
| Zoom range | 25% to 400% (50% to 200% using RSPF) in 1% increments |
| Preset copy ratios*6 | Metric: 10 ratios (5R/5E), inch: 10 ratios (5R/5E) |

*1: Long-edge feeding. *2: Short-edge feeding only. *3: In a standard measurement environment. May vary depending on operating conditions and environment. *4: 128 MB memory provided by optional MX-EB21 and 256 MB by optional AR-NB8. *5: Long-edge feeding from 1st paper tray. May vary depending on operating conditions and environment. *6: Preset copy ratios of 25% and 400% cannot be used with RSPF. *7: Resolution will vary depending on the size of the scanned area. *8: Colour/greyscale only. *9: Available only with Button Manager. *10: Requires optional AR-NB8. *11: Requires Button Manager. However, if installing AR-NB8, requires Network Scanner Tool Lite (instead of Button Manager). *12: Windows Server requires optional AR-NB8 and AR-PB10; Mac OS requires optional AR-NB8, AR-PB10, and MX-PK10. *13: Requires optional AR-NB8 and AR-PB10. *14: Requires optional AR-NB8, AR-PB10, and MX-PK10.

• Design and specifications are subject to change without prior notice.
• Microsoft, Windows, and Windows Server are registered trademarks of Microsoft Corporation in the US and/or other countries. PCL is a registered trademark of Hewlett-Packard Company. PostScript 3 is either a registered trademark or trademark of Adobe in the US and/or other countries. Mac is a trademark of Apple Inc., registered in the US and other countries. All other brand names and product names may be trademarks or registered trademarks of their respective owners.

SYSTEM CONFIGURATION

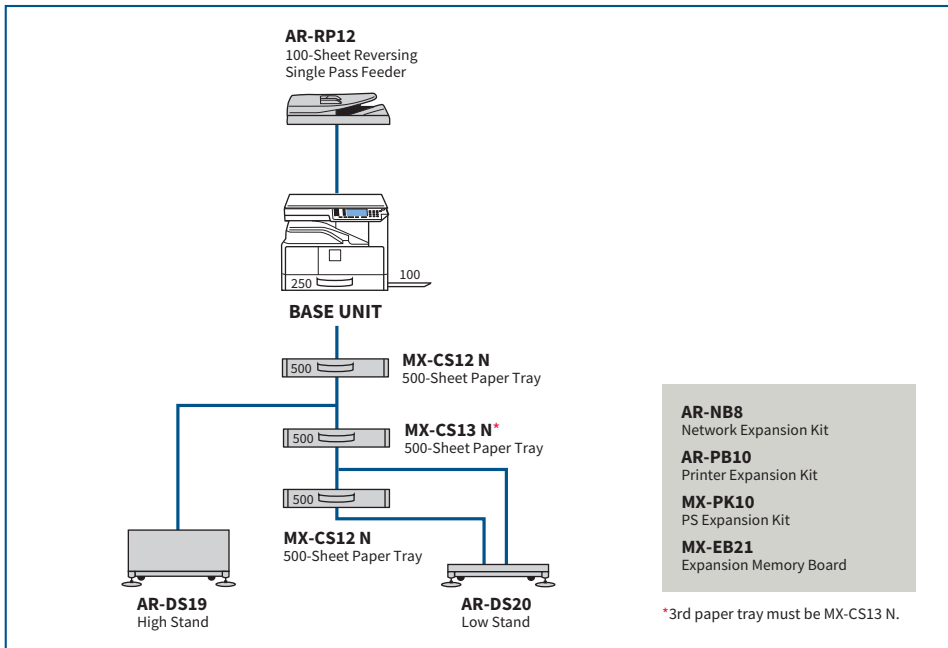

Certain optional equipment may not be available in some areas.

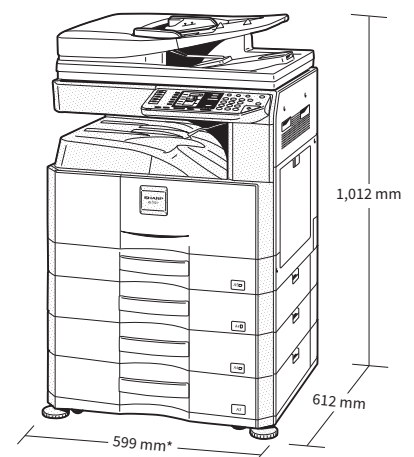

*Including adjuster.
909 mm when multi-bypass tray is extended.

Shown with optional equipment.

Distributed by:

SHARP