



Reasonable solution for your business



Support quick and flexible event organization

Easy assembly allows you quick installation in various event scenes. Flexibility of position is fulfilled with a moveable stand.

*Contents to display and player are not included in the product.
*Required separately sold Multi-monitor Floor stand (FS2B2).



Large screens will provide greater detail for teaching

120 inch view allows you to capture the every detail to realize the best of your teaching, even from distance far away.

*Equipment for video conference is not included.
*Required separately sold Multi-monitor Floor stand (FS2B2).



Improve your employee engagement

Four split screens can be combined together into one image on this Multi-monitor. The information source such as regular business reports can be updated using PC, to encourage your employee with active communication.

*Contents to display and player are not included in the product.
*Required separately sold Multi-monitor Floor stand (FS2B2).



Leave it up to AQUOS to explain specialty

Pre-set five time slots. Contents will be automatically switched according to the built-in clock, to show customers your best offers at the right time.

* Contents to display is not included in the product.



Why choose CP1X for your business?

1. Get a 120 inch Multi-monitor with ease

With SHARP Multi-monitor package, you can install 120 inch easily.



*Compared to the average banner size 800mm x 2000mm

3. High quality 4K display

Up-converts from HD/2K sources to 4K. Contrast / Colour optimized.



2. Management free daily contents

Contents auto-switched according to the built-in clock. All you have to prepare is USB pendrive.

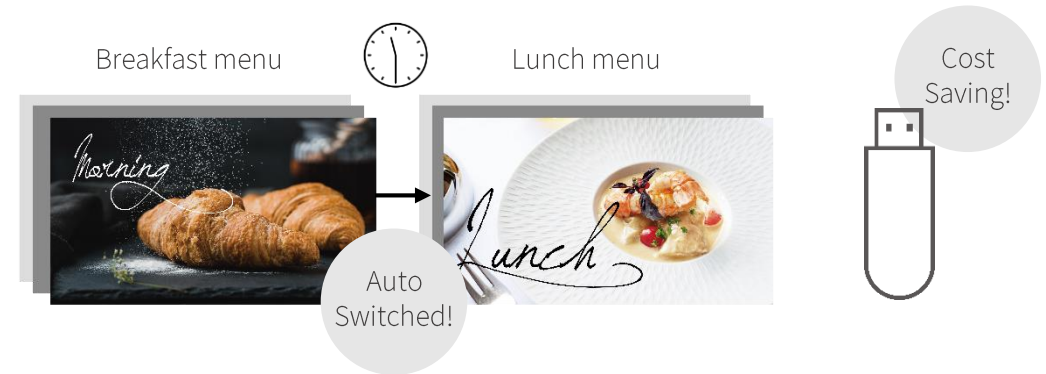

4. Panel made in Japan

Quality assured. Conduct & pass 7 and more rigorous tests.

日本製のパネル
Panel Made in Japan

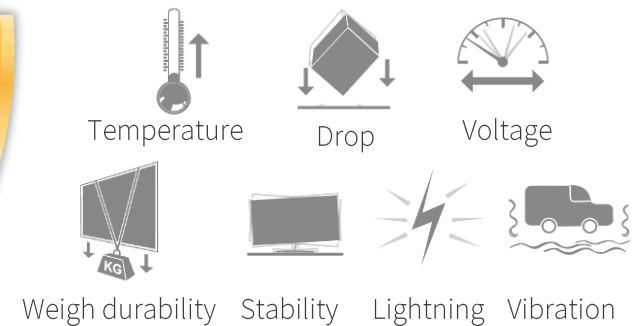

Easy installation

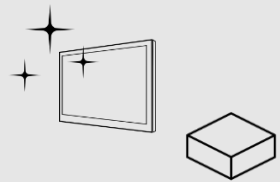
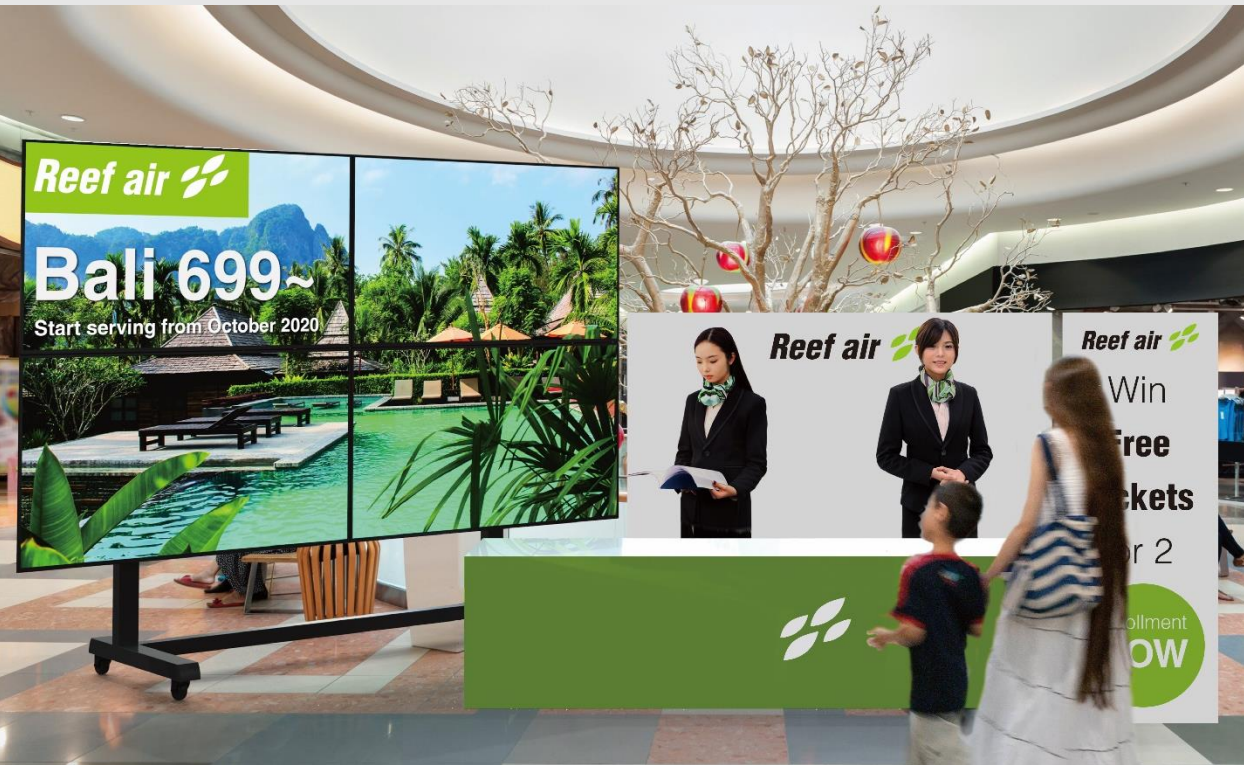

Buy TV & DIY package



No need installer



Go BIG from today

DIY* package for 2x2 Multi-monitor

Get it done without installer.

* Please set up with minimum three people.

DIY package

Multi-monitor
Floor stand

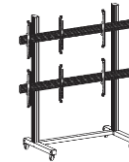

Multi-monitor
Setting APP



Movable floor stand

Setup freely according to the purpose of your event/meeting.



*Design is subject to change without prior notice.

Assist for setting/adjustment

Multi-monitor Setting APP helps you to set up and adjust the gaps and to get much closer to parity between multi monitors.



Multi-monitor
Setting APP

Max. 8K resolution*

* 8K contents and player which can be connected with HDMI 2.0 shall be prepared by customers. For details, please consult with SHARP Service center, your local authorized Sharp dealer or representative,

* 8K resolution is achieved by combination of four 4K images on 4 multi displays.

8K

Easy content management

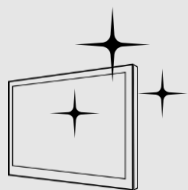

Buy CP1

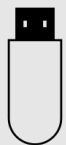

Prepare your contents



Get attention from today

Auto content management

Max. five time slots. Contents change automatically* out of the images in USB according to time slots.

Slideshow APP

*TV must be turned on



Breakfast / 7:00-11:00

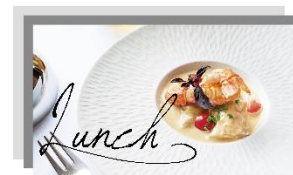

Lunch / 11:00-13:00



Afternoon Tea / 13:00-15:00

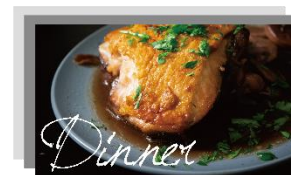

Dinner / 17:00-21:00



Bar / 21:00-24:00

<Format recommended>

Picture	JPEG/PNG/BMP
Audio	MP3/AAC/WMA

Prevent unexpected black out

Comes with USB locking wire.



Hotel solution

Various connection for hotel



WiFi
(wireless)



LAN
(wired)



RS-232C*
(wired)

*Required RS-232C Converter

*RS232C convertor
QCNWGA204WJPZ
(sold separately)

Φ3.5mm jack



D-SUB 9pin

Apply same setting to the rest (USB Cloning)

Set an AQUOS as you wish and save to USB.

You can set up as many just plugging the USB.
No need to set TVs one by one using remote controller.

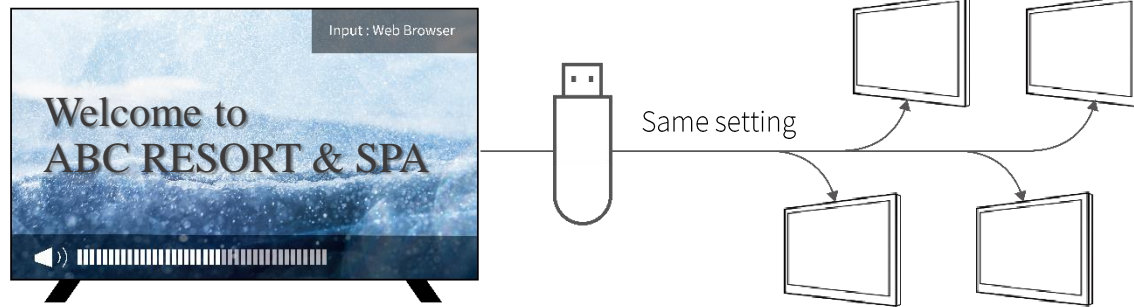

*The image is for illustrative purpose only.

TV broadcasting receiver



Assure safe product operations & endurance

All SHARP products passed the strict Japanese quality standard. SHARP TV is proven to have safe operation and high endurance under various circumstances.



Convenient tools for business use

Prevent from USB theft



USB locking wire x 5pcs



Prevent from HDMI disconnection



HDMI locking clamp x 3pcs



Detachable LED lens

CP1 has popped-out LED lens to receive signal.

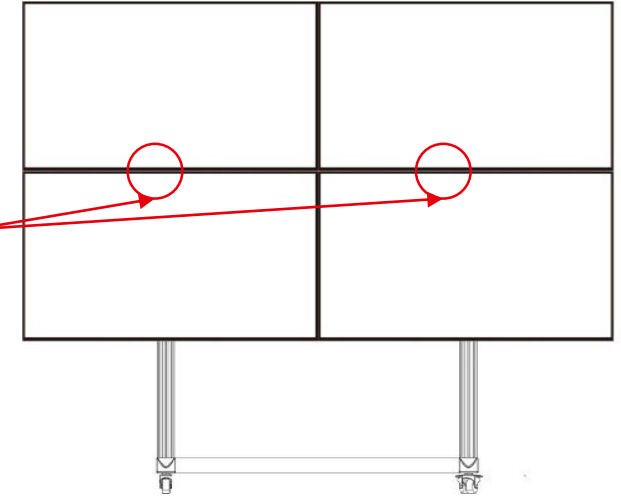
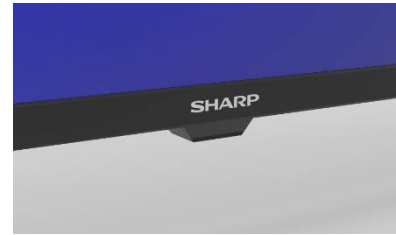

Only with a Phillips screwdriver

Product design



High light

Easy installation

Easy management

Other

Accessories

Specification

Terminals / Dimensions / Weight

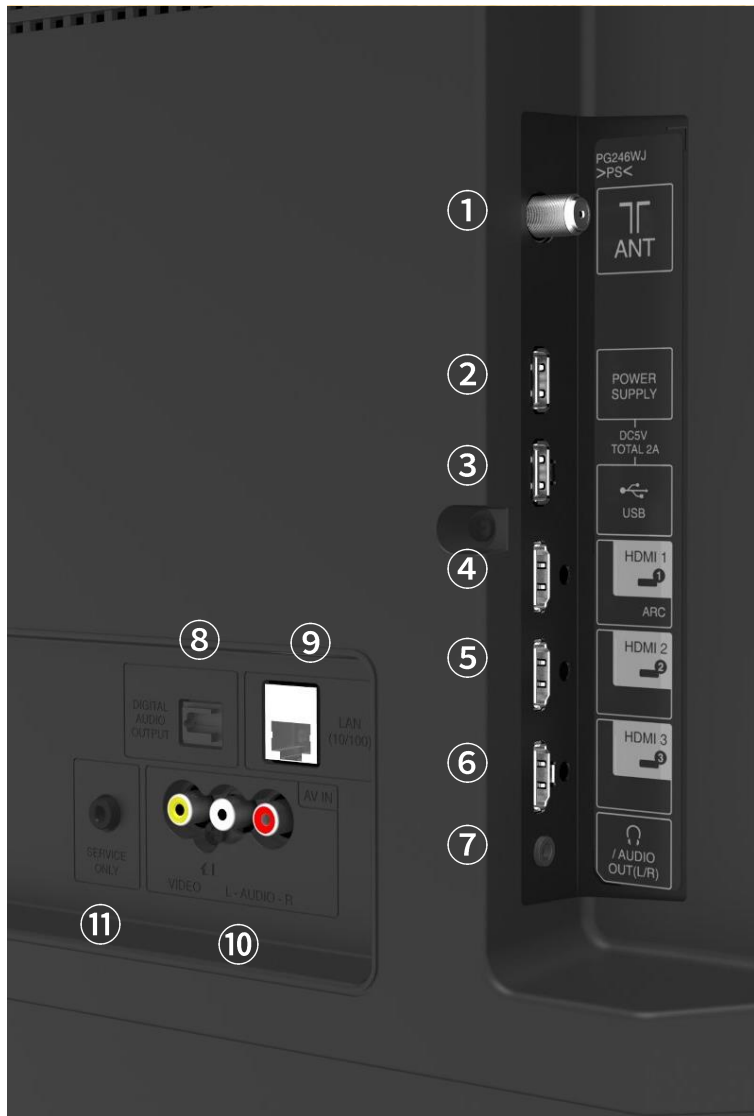

- ① Antenna
- ② USB Port (Power Supply)
- ③ USB Port (2.0)
- ④ HDMI 1
- ⑤ HDMI 2
- ⑥ HDMI 3
- ⑦ Headphone/
Audio Out(L/R)
- ⑧ Digital Audio Output
- ⑨ LAN
- ⑩ AV IN (Video, L/R)
- ⑪ Service Only (RS232C input*)
*Required RS232C converter

Dimensions/Weight (1unit)

	(w/ Stand)	(w/o Stand)
Dimensions (W x H x D) (mm)	1,358 x 864 x 300	1.358 x 790 x 83
Weight (kg)	18.5	17.5

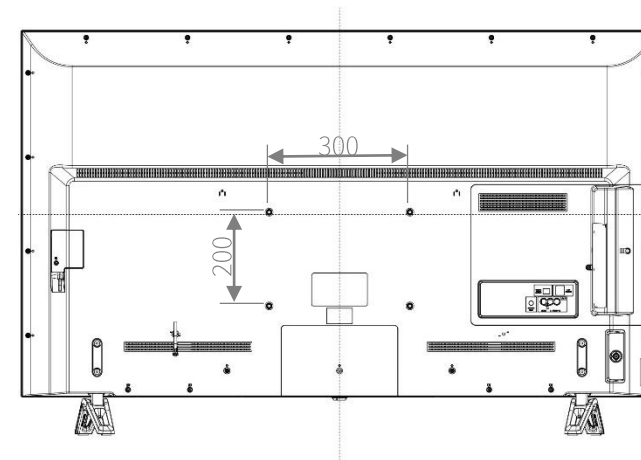
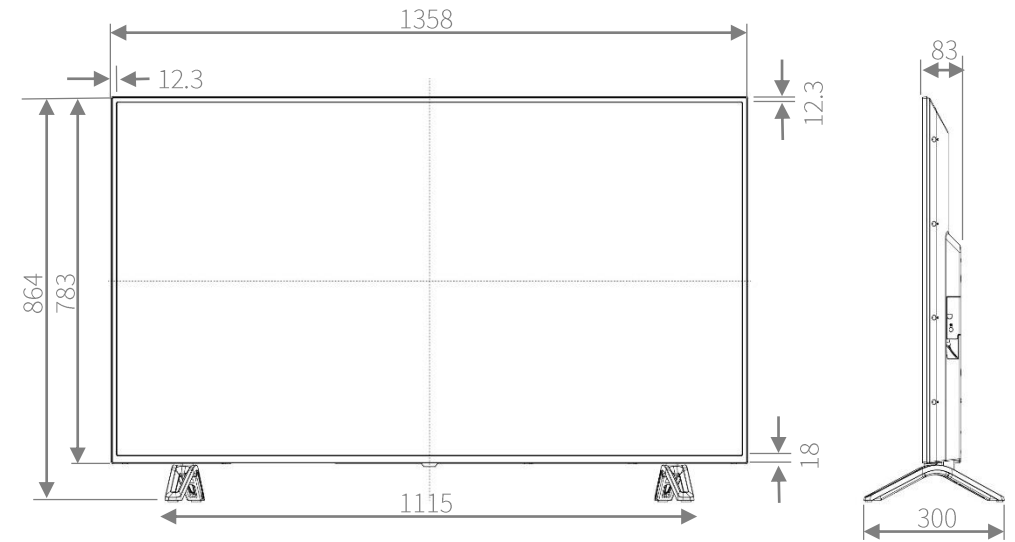

Terminals / Dimensions / Weight

Dimensions/Weight(4unit)

Dimensions (W x H x D) (mm)	2716 X 2266 (max) x 950
Weight (kg) approx.	117

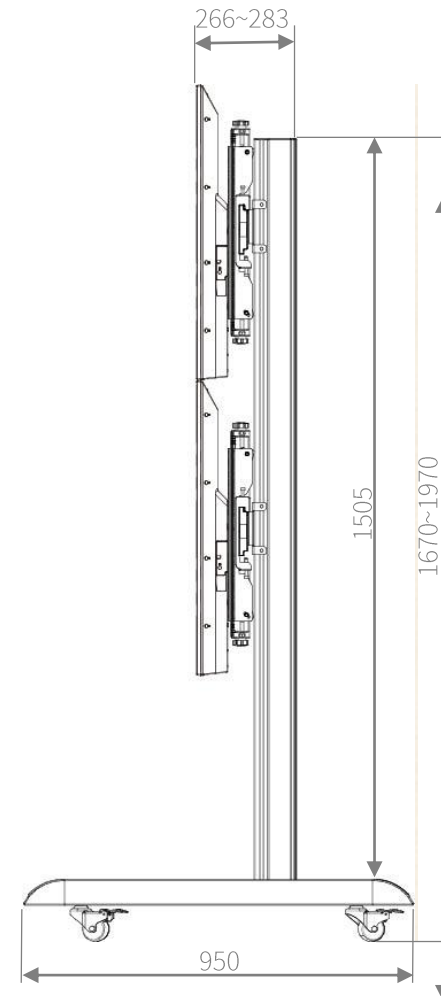
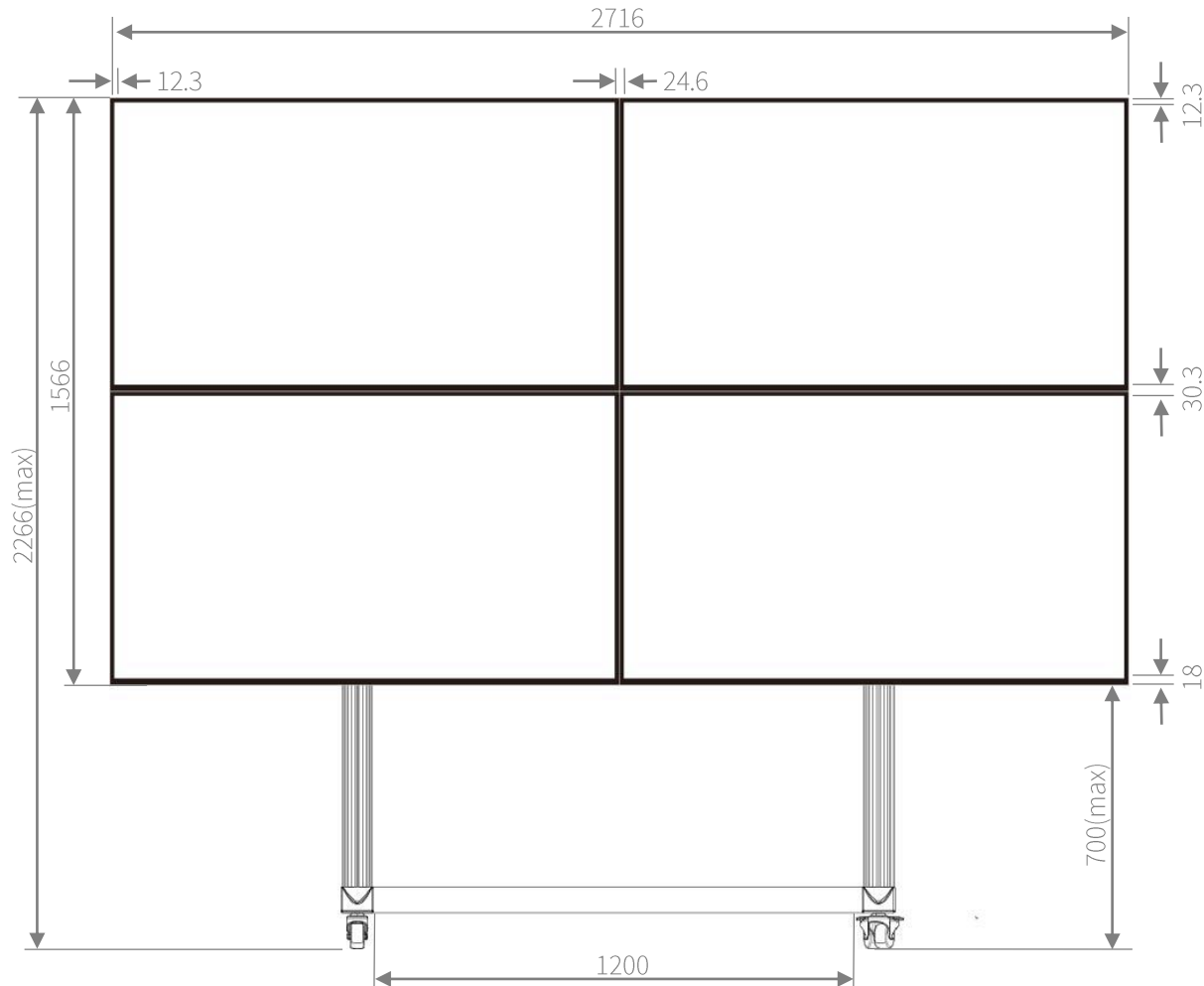

Dimensions/Weight (Multi-monitor Floor stand)

Dimensions (W x H x D) (mm)	(1010~1970) x (1670~1970) x 950
Weight (kg) approx.	47

2x2 Multi-monitor Floor stand
FS2B2 (supplied by Eagle Mount)

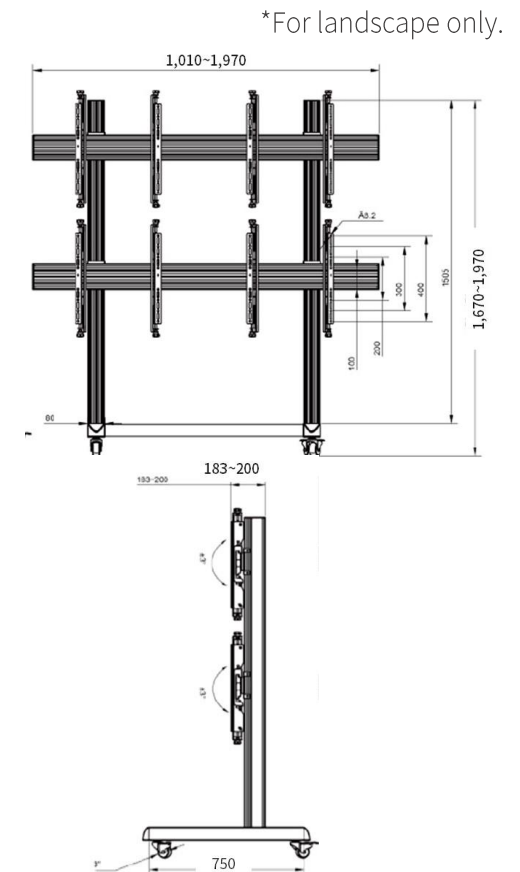

*Design and specification are subject to change without prior notice.

Specifications

Model Name	4T-B60CP1	
Operating hours	16hours / 7days	
Installation	Landscape / Portrait *2	
Sound output	10w x2	
LCD panel	60 inch widescreen (152.7cm diagonal) TFT LCD	
	Max. Resolution	3840 x 2160 pixels
	Max. Display Colours (approx.)	16.77 million colours
	Pixel Pitch (H x V)	0.3465 x 0.3465 mm
	Brightness*1	300cd/m ² typ.
	Contrast Ratio*1	4000:1 typ.
	Viewing Angle (H/V)	176° / 176° (CR \geq 10)
	Active Screen Area (W x H)	(approx.) 1330.6 × 748.4 mm (42.386"x29.465")
	Response Time	8.8 ms (gray to gray, avg.)
	Backlight	LED, direct type

Input Terminal*3	HDMI™*4 x 3, RCA video x 1, RCA L/R x 1, Antenna (DIN type) x1	
Output Terminal*3	Digital audio output x1, USB power supply x 1, Φ 3.5mm audio out (headphone)x 1,	
Input/Output Terminal*3	LAN port, USB x 1, Service only(Φ 3.5 mm jack)	
Mounting	VESA (4 points)*5300 x 200 mm pitch	
Power supply	110V - 240V AC, 50/60Hz	
Power Consumption	185 W	
AC cord	3m	
Environmental Conditions	Operating Temperature	0°C to 40°C *7
	Operating Humidity	20% to 80% RH (no condensation)
Dimensions*6 (W x D x H) (without Stand)	1358 x 300 x 864 mm (1358 x 83 x 790 mm)	
Weight (w/o stand)	18.5 kg (17.5 kg)	
Main Accessories	Remote controller x 1, AAA manganese battery x 2 , Stand x 1set, HDMI locking clamp x3, USB locking wire x5	
Option (sold separately)	AN-MMSTP1 / FS2B2	

*1 Brightness and contrast ratio depend on input mode and other picture settings. Brightness level will decrease slightly over the lifetime of the product. Due to the physical limitations of the equipment, it is not possible to maintain a precisely constant level of brightness. *2 OSD menu does not rotate. Remains landscape position. *3 Use a commercially available connection cable for PC and other video connections. *4 For both PC and AV components. *5 To use the VESA-standard mounting bracket, use M6 screws that are 8 to 10mm plus the thickness of the bracket *6 Display only, not including protrusions. *7 When using portrait condition, keep it within +/- 20 degrees. When using Multi-monitor and portrait condition, these operating temperature: 0 to 35°C.”