

SHARP

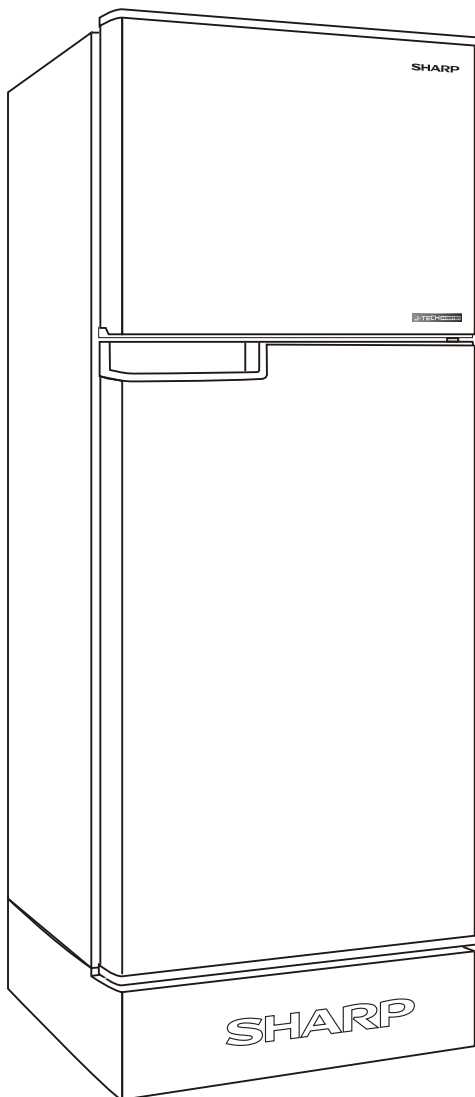

Refrigerant; HFC-134a
Insulation blowing gas; Cyclopentane
冷媒種類 ; HFC-134a
絕緣發泡材主要成份 ; 環戊烷



REFRIGERATOR - FREEZER OPERATION MANUAL

CONTENTS

• DESCRIPTION	2
• WARNING	3
• CAUTION	3
• INSTALLATION	3
• OPERATION	4
• CARE AND CLEANING	5
• STORING FOOD	5
• BEFORE YOU CALL FOR SERVICE	6

Household use only
Free standing type

原裝進口電冰箱 使用說明書

目錄

• 各部位名稱	7
• 警告	8
• 安全注意事項	8
• 安裝	8
• 使用方法	9
• 食品的儲存	10
• 保養	10
• 送修之前的初步檢查	11

僅限於家庭用途
獨立型

DESCRIPTION

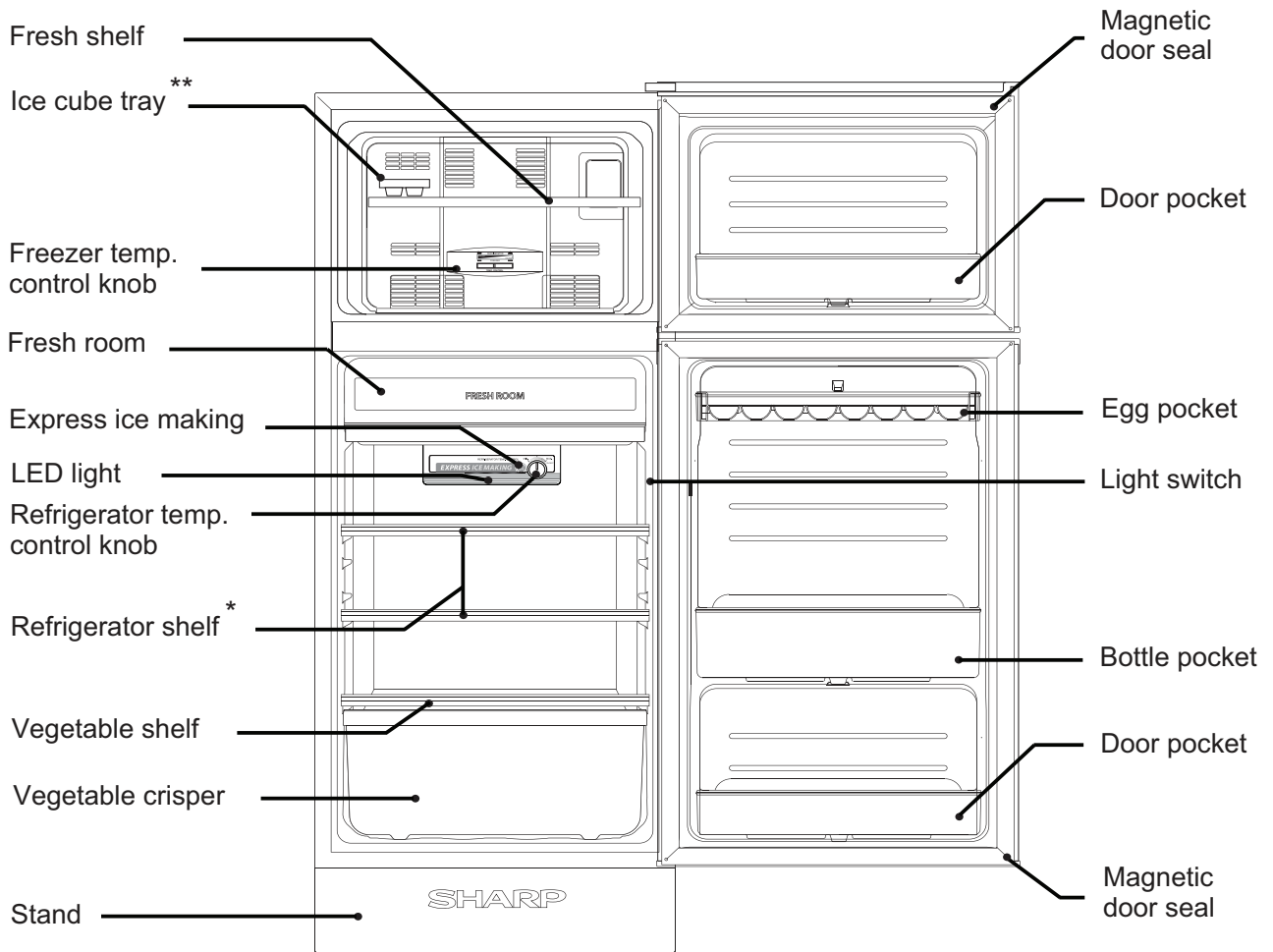

*

Model name	SJ-189M	SJ-209M SJ-D210M
Refrigerator shelf	1	2

**

“ Please put ice cube maker on the left side of freezer tray (same as photo) when you use Express Ice Making function. ”

WARNING

1. Highly volatile and flammable materials such as ether, petrol, propane gas, adhesive agents and pure alcohol etc. are liable to explode. Do not store these materials in the refrigerator.
2. Dust deposited on the power plug may cause fire. Wipe it off carefully.
3. Do not attempt to change or modify this refrigerator. This may result in fire, electric shock or injury.
4. Ensure that the refrigerator presents no danger to children while being stored for disposal. (e.g. remove the door to prevent child entrapment.)
5. This refrigerator should be disposed appropriately. Take the refrigerator to a recycling plant for flammable insulation blowing gases.
6. If the supply cord is damaged, it must be replaced by the manufacturer, its service agent or similarly qualified persons in order to avoid a hazard.
7. Don't use any tools or components for accelerated defrosting time, unless it is indicated in SHARP Manual.
8. Don't let anything damage the cooling system.
9. Don't put any electric component inside the cabinet, unless it is indicated in SHARP Manual.

CAUTION

1. Do not touch the compressor unit or its peripheral parts, as they become extremely hot during operation and the metal edges may cause injury.
2. Avoid touching the side wall cabinet as it may reach high temperature during normal operation.
3. Do not touch foods or metal containers in the freezer compartment with your wet hands. This may cause frostbite.
4. Do not use an extension cord or adapter plug.
5. Do not place bottled and canned drinks in the freezer as they may crack when frozen.
6. Make sure that the power cord has not been damaged during installation or moving. If the power plug or cord is loose, do not insert the power plug. There is a risk of electric shock or fire.
7. Disconnect from the mains electricity supply by removing the mains plug from the electricity supply socket. Do not remove by pulling the mains lead. This may cause electric shock or fire.
8. The refrigeration system behind and inside the refrigerator contains refrigerant. Do not allow any sharp objects to come into contact with the refrigeration system.
9. In case of gas leak, ventilate the area by opening a window, etc. Do not touch the refrigerator or the power outlet.
10. Do not place objects containing liquid or unsteady objects on top of refrigerator.
11. This refrigerator is not intended for use by persons (including children) with reduced physical, sensory or mental capabilities, or lack of experience and knowledge, unless they have been given supervision or instruction concerning use of the refrigerator by a person responsible for their safety. Young children should be supervised to ensure that they do not play with the refrigerator.

INSTALLATION

WARNING

- Do not install the refrigerator in a damp or wet location as this may cause damage to the insulation and a leak. Condensation may also build on the outer cabinet and cause rust.
- In order to prevent possible electric shock, install the grounding wire to the earth wire connecting screw at the rear of the refrigerator. (2 pin plug region)

Keep adequate ventilation space around the refrigerator.

- The figure shows the minimum required space for installing the refrigerator. The amount of power consumption.
- Insufficient spacing will decrease cooling efficiency and increase energy consumption. This may reduce the life of the unit and void warranty.
- If using the refrigerator in the smaller space dimension than the below figure, it may cause the temperature rise in the unit, loud noise and failure.
- The space between the rear of the refrigerator and the wall should be between 60 mm to 75 mm.

NOTE :

- Position your refrigerator so that the plug is accessible.
- Keep your refrigerator out of direct sunlight.
- Do not place next to heat generating appliance.
- Do not place directly on the ground. Provide suitable stand.

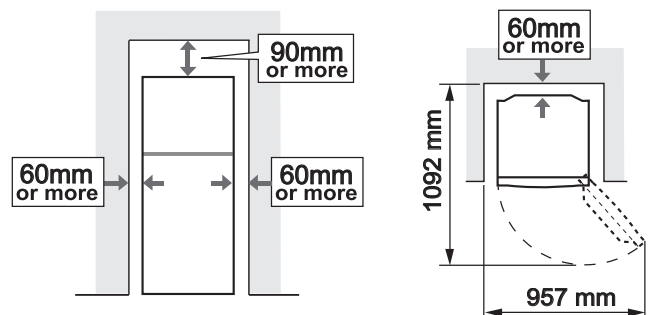

Before using your refrigerator

Clean the inside parts with a cloth soaked in warm water. If soapy water is used, wipe it off thoroughly with water.

OPERATION

Controlling temperatures

FREEZER TEMP. CONTROL

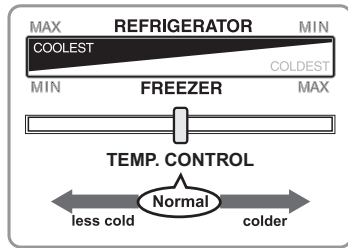

- FREEZER TEMP. CONTROL regulates the quantity of cold air to the freezer.
- If the freezer does not cool even when setting FREEZER TEMP. CONTROL to MAX, set REFRIGERATOR TEMP. CONTROL to MAX as well.
- With FREEZER TEMP. CONTROL set to MAX, there will be less cold air directed to the refrigerator compartment, and the refrigerator compartment may not become cold enough.

REFRIGERATOR TEMP. CONTROL

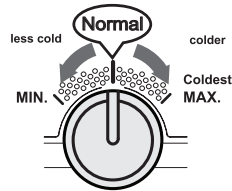

- REFRIGERATOR TEMP. CONTROL controls the compressor running time of the refrigeration system.
- MAX setting will result in colder temperature in the both (refrigerator and freezer) compartments.
- The freezer compartment may not cool sufficiently when leaving REFRIGERATOR TEMP. CONTROL as MIN for an extensive period. To cool the freezer compartment properly, set REFRIGERATOR TEMP. CONTROL closer to MAX.

■ Over 35°C ambient temperature

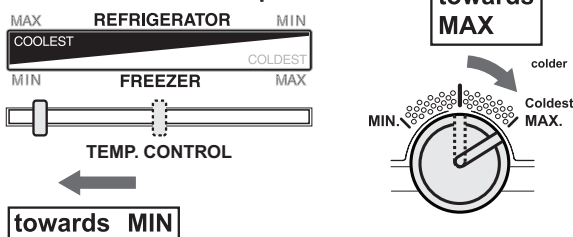

This is because MAX setting (FREEZER TEMP. CONTROL) may result in too little air flow to the refrigerator compartment, causing too warm temperature in the refrigerator compartment.

■ Under 10°C ambient temperature

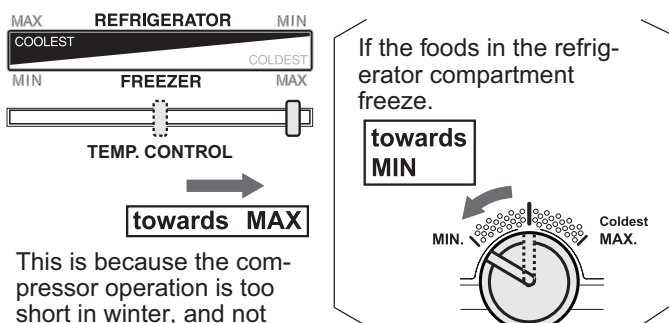

This is because the compressor operation is too short in winter, and not enough cold air is provided to the freezer compartment.

Hints when making ice

1. Pour the water into the cube tray to the water level line.
2. When the ice is made, twist the ice cube tray to take out the ice.

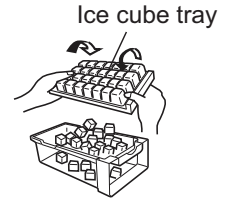

Express ice making

Ice cubes can be made quicker than normal.

1. Press the "EXPRESS ICE MAKING" button for 3 seconds. (Light will blink.)

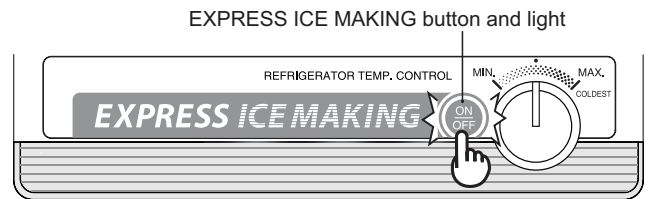

2. Set FREEZER TEMP. CONTROL at MAX to prevent the food in the refrigerator compartment from being frozen.
3. Express Ice Making ends automatically in about 2 hours regardless of ice condition.

- In the case operation overlaps with defrosting, Express Ice Making may require more than 2 hours. After the defrosting is completed, the operation will start.

To cancel operation

Press the "EXPRESS ICE MAKING" button for 3 seconds again. (Light will stop blinking.)

Tips for ice making time

Standard time to complete the ice making is approximately 1 hour. (This is a guide when 25 °C water is used where the room temperature is 30 °C.)

- Ice making time may become longer than above description depending upon room temperature, water temperature and the frequency of opening and closing of the door etc.
- Ice making cannot be complete in approx. 1 hours if the water is poured over the water level line. It is also difficult to remove the ice.

NOTE

- Ice making can not be completed in approx. 1 hour if the FREEZER TEMP. CONTROL or REFRIGERATOR TEMP. is set at MIN.
- After ice making is completed, adjust FREEZER TEMP. CONTROL to an original position.
- Do not open the door frequently during the operation.
- When the refrigerator has a power failure during operation of Express Ice Making, this operation is stopped at the time of re-power distribution.

Ag⁺ Nano Deodorizing unit

Deodorizing catalyst is installed on the routes of cold air. No operation and cleaning are required.

Defrosting

Defrosting is fully automatic due to a unique energy saving system.

STORING FOOD

Refrigeration reduces the rate of food spoilage. To maximize the shelf life of perishable food products, ensure that the food is of the freshest possible quality. The following is a general guide to help promote longer food storage.

Fruit / Vegetables

To minimize moisture loss, fruit and vegetables should be loosely enclosed in a plastic material e.g. wrap, bags (do not seal) and place in the vegetable crisper.

Dairy Products & Eggs

- Most dairy products have a use by date on the outer packaging which informs the recommended temperature and shelf life of the product.
- Eggs should be stored in the Egg pocket.

Meats / Fish / Poultry

- Place on a plate or dish and cover with paper or plastic wrap.
- For larger cuts of meat, fish, or poultry, place to the rear of the shelves.
- Ensure all cooked food is wrapped securely or placed in an airtight container.

NOTE :

- Evenly place the food on the shelves to allow the cooling air to circulate efficiently.
- Hot foods should be cooled before storing. Storing hot foods increases the temperature in the unit and increases the risk of food spoilage.
- Do not block the outlet and inlet of the cool air circulating circuit with foods or containers; otherwise the foods will not be evenly cooled throughout the refrigerator.
- Do not place food directly in front of cold air outlet. This may lead to the food freezing.
- Keep the door securely closed.

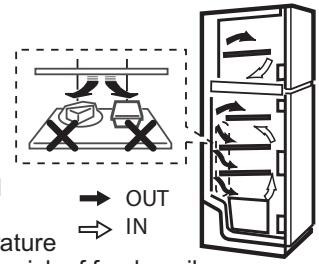

FOR BEST FREEZING

- Quality of foods should be fresh.
- Freeze small quantities of food at a time to freeze them quickly.
- Food should be properly stored or covered and the air should be removed to seal tightly.
- Evenly place the food in the freezer.
- Label bags or containers to keep an inventory of freezing food.

CARE AND CLEANING

WARNING

- **Unplug the refrigerator first to prevent electric shock.**
- **Do not splash water directly on the outer cabinet or the interior. This may lead to rusting and deterioration of the electrical insulation.**

IMPORTANT

To prevent cracking on inside surfaces and plastic components, follow these tips.

- Wipe any food oils adhered to plastic components.
- Some household chemicals may cause damage, so use only diluted washing-up liquid (soapy water).
- If undiluted detergent is used or soapy water is not wiped off thoroughly, cracking of plastic parts can result.

1. Remove the shelves and pockets from the cabinet and door. Wash them in warm soapy dishwashing water; rinse in clean water and dry.
2. Clean the inside with a cloth soaked in warm soapy dishwashing water. Then, use cold water to wipe off soapy water.
3. Wipe the exterior with a soft cloth each time it is soiled.
4. Clean the Magnetic door seal with a toothbrush and warm soapy dishwashing water.

NOTE

- To prevent damage to your refrigerator, do not use heavy duty cleansers or solvents (lacquer, paint, polishing powder, benzene, boiled water, etc.).
- If the power supply is disconnected, please wait for at least 5 minutes before re-connecting power.
- Do not drop objects inside the refrigerator or strike the inner wall. This may cause the inner surface to crack.

When the compartment light is blown

Contact the service agent approved by SHARP to request a replacement compartment light. The compartment light is not to be removed other than by qualified service personnel.

Switching off your refrigerator

If you switch your refrigerator off when you are going away for an extended period, remove all food, clean the interior thoroughly. Remove the power cord plug from the power socket and leave all doors open.

BEFORE YOU CALL FOR SERVICE



Before you call for service, check the following points.

Problem	Solution
The outside of a cabinet is hot when touched.	It is normal. The hot pipe is in the cabinet in order to prevent dew generation.
When there is refrigerator noise.	It is normal for the refrigerator to produce the following sounds. <ul style="list-style-type: none"> • Loud noise produced by the compressor when operation starts --- Sound becomes quieter after a while. • Loud noise produced once a day by the compressor --- Operating sound produced immediately after automatic defrost operation. • Sound of flowing fluid (gurgling sound, fizzing sound) --- Sound of refrigerant flowing in pipes (sound may become louder from time to time). • Cracking or crunching sound, Squeaking sound --- Sound produced by expansion and contraction of inner walls and internal parts during cooling.
Frosting or dew generation occurs inside or outside the refrigerator.	This may occur in one of the following cases. Use a wet cloth for wiping frost and a dry cloth for wiping dew. <ul style="list-style-type: none"> • When the ambient humidity is high. • When the door is frequently opened and closed. • When foods containing plenty of moisture are stored. (Wrapping is required.)
The foods in the refrigerator compartment freeze.	<ul style="list-style-type: none"> • Is the refrigerator operated for a long time with REFRIGERATOR TEMP. CONTROL set at MAX? • Low ambient temperature may cause placed foods to freeze even if REFRIGERATOR TEMP. CONTROL is set to MIN.
It smells in the compartment.	<ul style="list-style-type: none"> • Wrapping is required for the foods with strong smell. • Deodorizing unit cannot remove all of smell.
Light in the refrigerator blinking.	Nothing is wrong with refrigerator if it operates under Express Ice making mode. This mode will automatically stop within 2 hours.

IF YOU STILL REQUIRE SERVICE Refer to your nearest service agent approved by SHARP.

各部分名稱

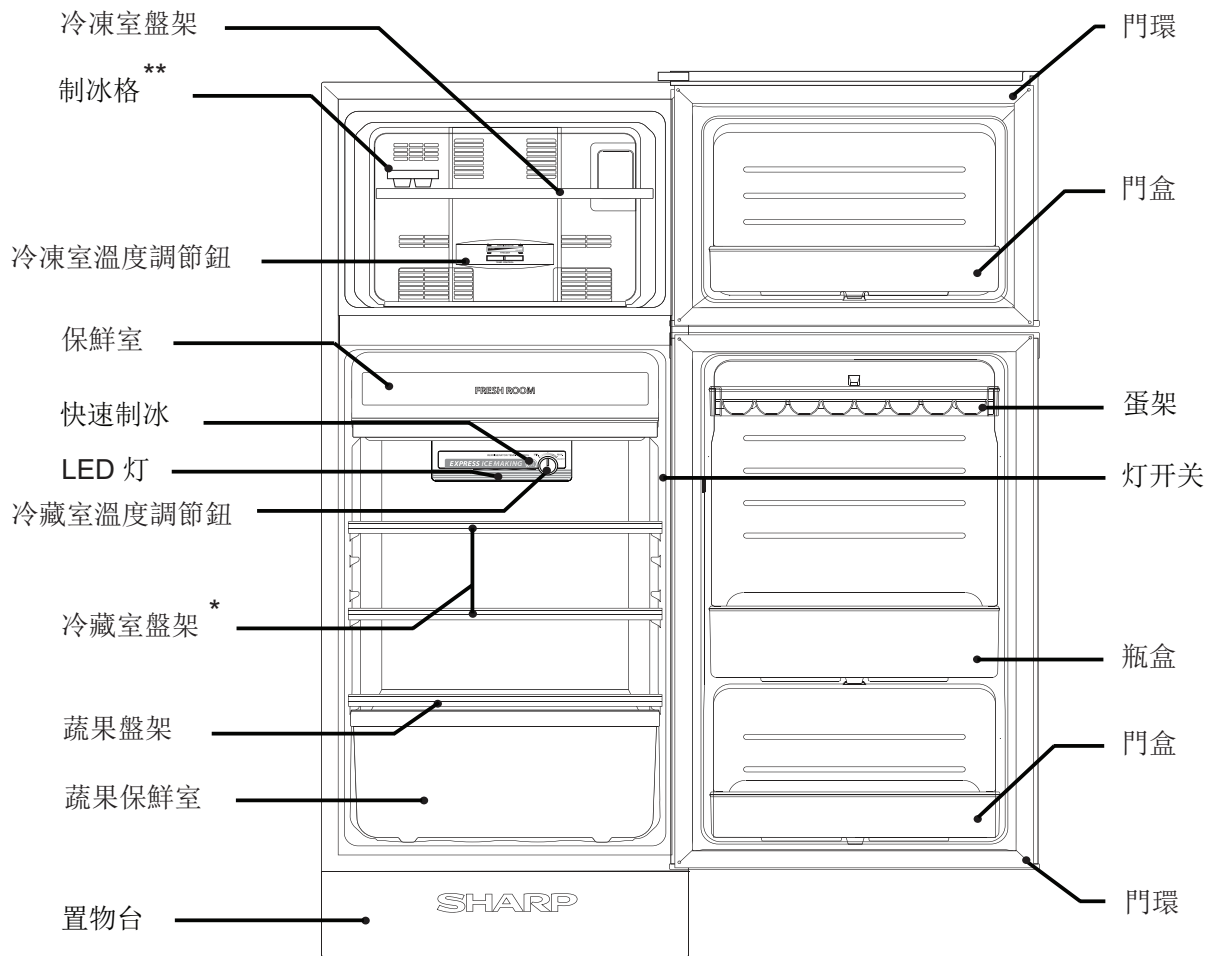

*

型名	SJ-189M	SJ-209M SJ-D210M
冷藏室盤架	1	2

**

“当您使用快速制冰功能时，请将制冰机置于冰箱托盘左侧（如图所示）。”

警告

1. 乙醚、汽油、丙烷氣、粘合劑、純乙醇等高揮發性物質和易燃性物質有爆炸之危險。請勿將這類物質保存在冰箱內。
2. 電源插頭上積滿灰塵是引起火災的原因。因此，請時常將其擦淨。
3. 請勿改裝冰箱。修理技術人員以外的人員拆卸和修理本機，會導致火災、觸電和受傷。
4. 確保冰箱在等候處理的存儲過程中不會給兒童帶來危險。（例如，拆除冰箱門以防兒童不慎卡入）
5. 請妥善處理冰箱進行。冰箱請運送至可燃性絕熱發泡氣體廢料處理廠。
6. 如果电源线损坏，则必须由制造商、其服务代理或类似资格人员更换，以避免危险。
7. 请勿使用任何工具或部件加速除霜时间，除非夏普手册中另有说明。
8. 请勿让任何东西损害制冷系统。
9. 请勿将任何电器元件置于冰箱内，除非夏普手册中另有说明。

安全注意事項

1. 由於壓縮機單元或者其外圍部件在操作過程中將變得非常燙手，千萬不要去觸摸，否則，將會被金屬邊緣燙傷。
2. 切勿接觸箱體外殼，因為在它在正常操作情況下可能達到高溫。
3. 不要用濕手去觸摸冷凍室內的食品 and 金屬製容器。恐會導致手凍傷。
4. 請勿使用電線插板或轉換插頭。
5. 因為瓶裝或罐裝飲料凍結後會碎裂，因此，請勿將這類東西放進冷凍室內。
6. 在安裝或移動的過程中，請確保電源線完好無損。如果電源插頭或電源線出現鬆動等情況，請勿插入電源插頭。否則會有觸電或引發火災的危險。
7. 拔出電源插頭時，請不要祇拉住電源線，應該拿住插頭端拔出。拉扯電源線會導致觸電和著火。
8. 冰箱內部及後側的製冷系統內含有製冷劑。請務必避免任何尖銳的物體碰觸製冷系統。
9. 萬一發生瓦斯氣漏事故，請勿用手去觸摸冰箱和插頭，要打開窗戶通風。
10. 請勿將裝有液體或非穩定物質的容器放在冰箱上。
11. 該冰箱不適合體力、感知能力或心理能力較弱，或經驗和知識缺乏者（包括兒童）使用，除非他們得到其安全負責人員給予有關冰箱使用的監督或指導。應監督年幼兒童，確保他們不玩弄冰箱。

安裝

警告

- 請勿將冰箱設置在濕氣多及濺得到水的地方。這樣會因絕緣失效而導致漏電。而且有時會在冰箱外側結露。
- 為防止觸電，請將地線連接至冰箱背面的地線用螺絲上。（2 腳插頭地區）

冰箱的周圍應確保足夠的通風空間。

- 图中显示放置冰箱所需的最小空间，以及功耗量。
- 空间不足会降低制冷效率，提高能耗。这可能减少设备寿命并使保修失效。
- 如果在小于下图所示的空间尺寸中使用冰箱，可能导致设备温度升高，噪声增大并发生故障。
- 冰箱后部与墙壁之间的距离应介于 60 毫米至 75 毫米之间。

請注意：

- 設置冰箱時要充分考慮便於插拔插銷。
- 請勿將冰箱放在直接照射到陽光的地方。
- 請勿將冰箱放在發熱機器的旁邊。
- 請勿將冰箱直接放在地面上。請準備適當的台座。

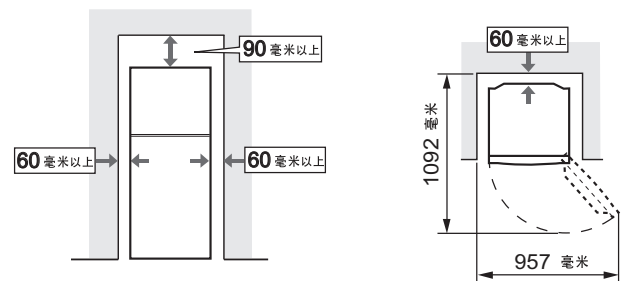

在使用冰箱前

用溫水浸泡過的軟布清潔冰箱內部。如果使用肥皂液，請用水徹底擦掉殘留肥皂液。

使用方法

溫度調節

冷凍室溫度調節
(FREEZER TEMP. CONTROL)

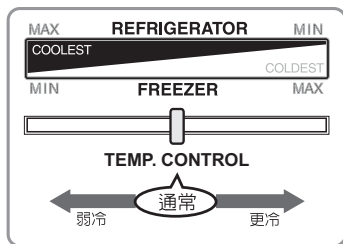

- FREEZER TEMP.CONTROL 調節進入冷凍室內的冷氣量。
- 即使將 FREEZER TEMP.CONTROL 調在 MAX，冷凍室的冷卻不佳時，請將 REFRIGERATOR TEMP.CONTROL 調節至 MAX 處。
- 將 FREEZER TEMP.CONTROL 轉鈕設定在 MAX 處將會減少進入冷藏室的氣量，致使冷藏室制冷不足。

冷藏室溫度調節
(REFRIGERATOR TEMP. CONTROL)

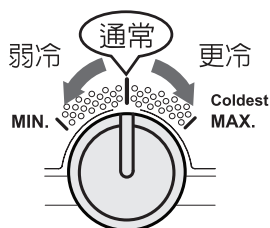

- REFRIGERATOR TEMP. CONTROL 控制冷卻系統中的壓縮機的運轉時間。
- 因此，將溫度設定在 MAX 處將會降低兩個儲藏室（冷凍室和冷藏室）的溫度。
- 若長期將 REFRIGERATOR TEMP. CONTROL 調在 MIN 處，冷凍室未必能冷卻。請將 REFRIGERATOR TEMP. CONTROL 調節至偏向 MAX 處，以適當地冷卻冷凍室。

■ 氣溫超過 35°C 時

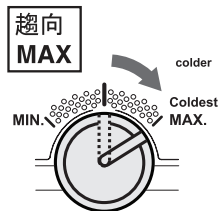
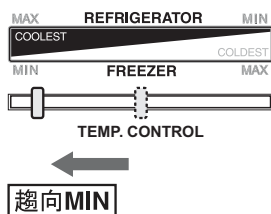

如果將溫度設定在 MAX 處 (FREEZER TEMP. CONTROL)，進入冷藏室的冷氣量就會減少，冷藏室就不會變冷。

■ 氣溫低於 10°C 時

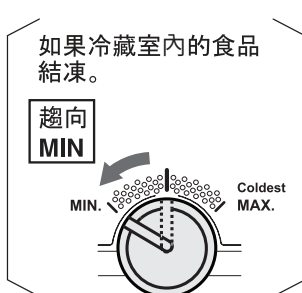
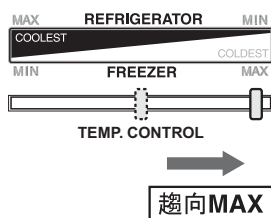

因為冬季壓縮機的運轉時間較短，因此，不會有足夠的冷氣進入冷凍室內。

制冰方式

1. 將水倒入制冰格至水位線。
2. 冰塊制好后，扭動制冰格取出冰塊。



快速制冰

其制冰速度比常規制冰更快。

1. 按“快速制冰”按鈕 3 秒。（指示燈將會閃動。）

“快速制冰”按鈕和指示燈

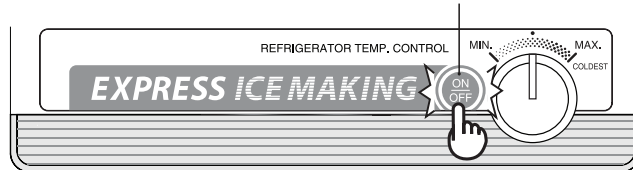

2. 將“冷凍室溫度調節”設為最大值，防止冷藏室內的食物凍結成冰。
3. 不論冰塊狀態如何，“快速制冰”均會在約 2 小時後自動終止。
 - 如果“快速制冰”操作與除霜交替進行，可能需要 2 個小時以上。除霜完畢後，操作即會啟動。

取消操作

再按“快速制冰”按鈕 3 秒。（指示燈將會停止閃動。）

制冰時間小貼士

完成制冰的標準時間約為 1 小時。

（這是室溫為 30 攝氏度且所用水的溫度為 25 攝氏度時的指導時間。）

- 水溫和冰箱門的開關頻率，制冰時間可能比上方所述的時間更長。
- 如果注入的水越過水位線，則無法在約 1 小時內完成制冰。這樣也很難取出冰塊。

請注意

- 如果“冷凍室溫度調節”或“冷藏室溫度”設為最小值，則無法在 1 小時內完成制冰。
- 制冰完成後，請將“冷凍室溫度調節”調至原位。
- 操作期間切勿頻繁打開冰箱門。
- 如果冰箱在“快速制冰”操作期間斷電，重新供電時，此操作才會繼續。

納米銀離子除臭裝置

已經將脫臭觸媒設置在冷氣的通道上。不需要進行操作和清潔。

除霜

本冰箱透過獨特的節約能源系統，完全實現自動除霜。

食品的儲存

將食品冷藏起來時，食品腐爛的速度就會減緩。要延長易於腐爛食品的保存期限，就應當盡可能選擇較新鮮的食品。下面為延長食品保存期限的簡要介紹，可供您參考。

水果 / 蔬菜

為儘量減少水份的流失，水果和蔬菜要用保鮮膜及袋子（不封口）之類的塑膠袋輕輕包上，並將其放入蔬果保鮮室內。

乳製品和雞蛋

- 幾乎所有乳製品的外包裝上都標有適當的保存溫度和保存期限。
- 請用箱內的蛋盒保存雞蛋。

肉類 / 魚 / 禽肉

- 請將其放在容器上，並包上保鮮膜。
- 若是大塊的肉、魚和禽肉，請將其放在盤架的內側。
- 已經煮熟的食品務須用保鮮膜包好，或將其放在密封容器內。

請注意：

- 為使冷氣充分循環，請將食品均勻地放在盤架上。
- 請將較熱的食品涼下來以後，才保存起來。如果將較熱的食品放進冰箱，冰箱內的溫度會升高，這樣往往很容易導致食品腐爛變質。
- 請勿讓食品和容器擋住使冷氣循環的出風口和吸入口。否則，食品就不能均勻地冷卻。
- 請勿直接將食品放在冷氣出風口旁。這樣會引致食品凍結。
- 請妥善關好冰箱門。

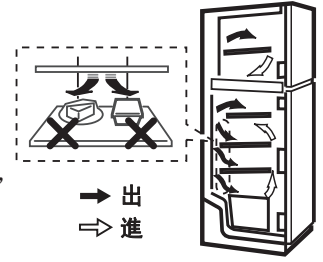

為達到最佳冷凍效果

- 食品質量應當新鮮。
- 若要快速冷凍食品，每次都必須少量放入。
- 食品應適當地放入容器或用保鮮膜包好，若要將食品密封起來，最好將空氣抽出。
- 將食品均勻地放入冷凍室。
- 袋子和容器上要標上標示，並寫清楚冷凍食品的內容。

保養

警告

- 為了防止觸電，首先拔掉冰箱的電源插頭。
- 請勿直接將水灑在冰箱的內部和外部。這樣會導致生鏽及絕緣性能下降。

重要提示

為防止冰箱內板表面和塑膠部件發生開裂，請遵從如下操作提示。

- 食用油沾上塑料部件時，請將之擦掉。
- 某些家用化學洗滌劑可能會導致冰箱損傷，因而只能使用稀釋過的廚房用洗滌劑（肥皂水）。
- 如果使用未稀釋的洗劑或者未徹底擦淨肥皂水，則有可能損壞冰箱的塑料部件。

1. 拆下冰箱內的盤架和冰箱的小物品架，瓶架。用溫水和廚房用洗滌劑清洗。用水洗清並使之乾透。
2. 冰箱內部要用浸泡在廚房用洗滌劑的溫水裡的布塊擦洗。然後，用冷水將肥皂水擦乾淨。
3. 冰箱的外殼沾上污漬時，請用柔軟的布塊擦洗。
4. 冰箱門環要用廚房用洗滌劑的溫水和牙刷洗淨。

請注意：

- 為避免損傷冰箱，請勿使用強力清潔劑或溶劑（油漆、塗料、拋光粉、汽油、沸水等）
- 供電中斷時，請等待至少 5 分鐘之後再重新接通電源。
- 在冰箱內請勿使物體掉落，或用物體強烈碰撞內壁。否則可能導致內壁破裂。

當冷藏室內燈損壞時

請聯繫 SHARP 服務中心要求更換冷藏室內燈泡。非專業服務人員不得更換冷藏室燈泡。

切斷冰箱的電源時

長期出門的時候，如果要切斷冰箱的電源，請取出冰箱內的全部食品，並將內部徹底擦洗乾淨。請從插座上拔出電源插頭，並打開冰箱門。

送修之前的初步檢查

送修之前，請對下列地方進行檢查。

問題	對策
冰箱外箱有時會變熱。	這並非異常。防止結露的熱導管裝在機身的內部。
冰箱發出噪聲時。	冰箱如發出下述聲音，這並非異常。 <ul style="list-style-type: none">• 運轉開始時，壓縮機發出較大的噪音 - - - 不久聲音會變小。• 壓縮機每日一次發出較大噪音 - - - 緊隨自動除霜操作之後發出的運轉聲。• 液體流動的聲音（咕嚕聲、嘶嘶聲） - - - 冷媒在管道內流動的聲音（聲音時而會變得較大）。• 劈啪聲或吱嘎聲，吱吱聲 - - - 冷卻時內壁和內部零件膨脹和收縮的聲音。
冰箱內部和冰箱外側結霜或結露。	在下列情形下有可能發生這種現象。請用濕布擦掉霜，用乾布擦掉露珠。 <ul style="list-style-type: none">• 周圍溫度較高時。• 頻繁開啟冰箱門時。• 冰箱內存放水分較多的食品時。（請用保鮮膜包上）
冷藏室的食品結凍。	<ul style="list-style-type: none">• 是否長期在 REFRIGERATOR TEMP. CONTROL 為 MAX 下使用冷藏室？• 在周圍溫度較低時，即使將冷藏室的溫度控制調到 MIN，食品有時也會被凍結。
冰箱內部有異味。	<ul style="list-style-type: none">• 請將氣味較強的食品用保鮮膜包起來。• 脫臭裝置不能去掉所有異味。
冰箱指示灯闪动。	如果在“快速制冰”模式下操作，則冰箱沒有任何故障。該模式將在 2 小時內自動停止。

經檢查後仍需要送修時 請與就近的 SHARP 售後服務中心洽詢。

SHARP

SHARP CORPORATION