

SHARP



Refrigerant: R600a
Insulation blowing gas: Cyclopentane

製冷劑：R600a
絕熱發泡氣體：環戊烷



"Plasmacluster" and "Device of a cluster of grapes" are trademarks of Sharp Corporation.



Refrigerator - Freezer Operation manual

Contents

- Safety information EN-1
- Installation..... EN-3
- Description EN-4
- Control panel EN-6
- Controlling temperature..... EN-7
- Storing food EN-8
- Care and cleaning..... EN-9
- Before you call for service..... EN-10

原裝進口電冰箱 使用說明書

目錄

- 安全注意事項 ZH-1
- 安裝 ZH-3
- 各部位名稱 ZH-4
- 控制面板 ZH-6
- 實用功能 ZH-7
- 食品的儲存 ZH-8
- 保養 ZH-9
- 送修之前的初步檢查 ZH-10

SJ-3822M	SJ-4122M
SJ-4422M	SJ-FTS13BVS
SJ-FTS11BVS	

ENGLISH



中文

Thank you very much for buying this SHARP product. Before using your SHARP refrigerator, please read this operation manual to ensure that you gain the maximum benefit from it.

- This refrigerator is intended for making ice cubes, refrigerating and freezing foods.
- This refrigerator is for household use only, with ambient temperature indicated in the table. The climate class is specified on the rating plate. If the refrigerator operates out of range (ambient temperature range) of the climate class which is rated for that model, it may not be able to maintain satisfactory internal temperatures. If the refrigerator is used at colder temperatures, the refrigerator will not be damaged up to a temperature of +5°C.
- The refrigerator should not be subjected to temperatures of -10°C or below for a long period of time.

Household use only	
Climate class	Acceptable range of ambient temperature
SN	+10°C to 32°C
N	+16°C to 32°C
ST	+16°C to 38°C
T	+16°C to 43°C

Safety information

	WARNING	This means that there are high risks of death or serious injury.
	CAUTION	This means that there are high risks of material damage or personal injury.
	CAUTION	Fire marks means this refrigerator has risk of fire accident.

WARNING

Refrigerant

This refrigerator contains flammable refrigerant (R600a: isobutane) and insulation blowing gas (cyclopentane). Observe the following rules to prevent ignition and explosion.

- Do not allow any sharp objects to have contact with the refrigeration system. The refrigeration system behind and inside the refrigerator contains refrigerant.
- Do not use mechanical devices or other means to accelerate the defrosting process. (This refrigerator has adopted automatic defrosting system.)
- Do not use electrical appliances inside the refrigerator.
- Do not block the space around the refrigerator.
- Do not use flammable sprays, such as spray paint near the refrigerator.
- In the case of failure of the refrigeration system, do not touch the wall socket and use open flames. Open the window and air out the room. Then ask a service agent approved by SHARP for service.

Power cord, Plug, Socket

Read carefully the following rules to prevent electric shock or fire.

- Make sure to protect the power cord from being damaged during installation or moving. If the power plug or cord is loose, do not insert the power plug.
- Do not place multiple portable socket-outlets or portable power supplies at the rear of the refrigerator.
- Connect the power plug into the wall socket firmly and directly. Do not use an extension cord or adapter plug.
- Connect the power plug to the socket with the required rated voltage.
- Connect the earth pin to the earth terminal properly.
- Do not touch the power plug with wet hands.
- Disconnect from the main electricity supply by removing the main plug from the socket. Do not remove by pulling the power cord.
- Dust deposited on the power plug may cause fire. Wipe it off carefully.

- Pull out the plug if the refrigerator is not used for a long time.
- If the flexible supply cord is damaged, it must be replaced by service agent approved by SHARP in order to avoid a hazard.

Installation

- Do not install the refrigerator in a damp or wet location. It may cause the damage to the insulation or electrical leak. Dew may also appear on the outer cabinet and it causes rust.
- The refrigerator should be installed flatly and firmly on the floor.

In use

- Do not store volatile and flammable materials such as ether, petrol, propane gas, aerosol cans, adhesive agents and pure alcohol etc. These materials are easy to explode.
- Do not store temperature-sensitive products such as pharmaceutical products in the refrigerator. There are high risks of changes in product quality.
- Do not attempt to change or modify this refrigerator. This may result in fire, electric shock or injury.
- Do not place bottled drinks and cans in the freezer compartment. Especially "Express Freezing" is in operation, there is a high risk that glass bottles may burst.
- Do not place any object on the top of refrigerator. If the object falls down from the top, it may cause injury.
- This appliance can be used by children aged from 8 years or above and persons with reduced physical, sensory or mental capabilities or lack of experience and knowledge if they have been given supervision or instruction concerning use of the appliance in a safe way or understanding the hazards involved. Children shall not play with the appliance. Cleaning and user maintenance shall not be done by children without supervision.

Care and Cleaning

- Unplug the refrigerator first to prevent electric shock.
- Do not splash water directly on the outer cabinet or the interior. This may lead to rusting and deterioration of the electrical insulation.

Trouble

- If you smell something burnt, pull out the power plug immediately. Then ask a service agent approved by SHARP for service.
- In case of gas leak, ventilate the area by opening window. Do not touch the refrigerator or the power socket.



CAUTION

Transportation

- When you install or move your refrigerator, use curing mat to protect the floor from being damaged.
- Carry the refrigerator securely. If you lift up the refrigerator improperly, it may cause injury.

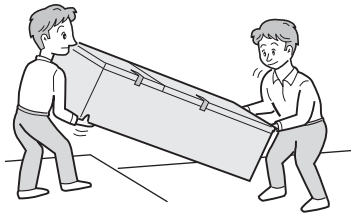

- Do not use the doors to carry the refrigerator.



- Make sure to contact the authorized service center before you install or move the refrigerator.

Disposal

- Ensure that the refrigerator presents no danger to children while being stored for disposal. (e.g. remove the magnetic door seals to prevent child entrapment.)
- This refrigerator should be disposed appropriately. Take the refrigerator to a professional recycling plant for flammable refrigerant and insulation blowing gases.

In use

- Do not touch the compressor unit or its peripheral parts, as they become extremely hot during operation and the metal edges may cause injury.
- Do not touch foods or metal containers in the freezer compartment with wet hands. This may cause frostbite.
- Do not use other than potable water to make ice cubes.
- Do not place bottled drinks and cans in the freezer compartment.
- Do not open or close the door when other people put a hand near the door. There is a risk that the other people may get their fingers caught in the door.
- Do not put oversized object in the pockets of the door. If the object falls down from the pockets, it may cause injury.
- Make sure to handle the glass shelves with care to install or uninstall. If you drop the glass shelves, it may break or cause injury.

- 1** Keep adequate ventilation space around the refrigerator.
The picture shows the minimum required space for installing the refrigerator. The measurement condition of energy consumption is conducted under a different space dimension.

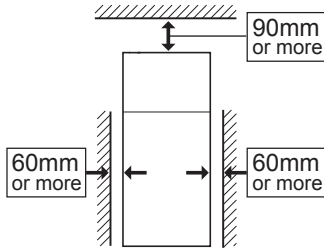

- 2** Use the adjustable foot to place the refrigerator flatly and firmly on the floor.

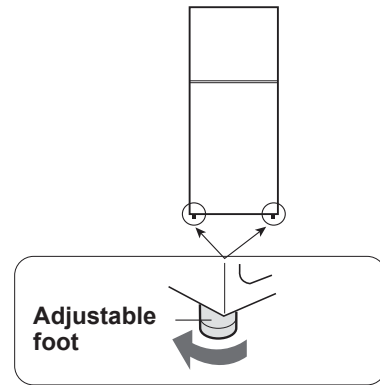

Rear clearance

The space between the rear of the refrigerator and the wall should be 50mm or more, and less than 75mm. If the space is wider than 75mm, you may get injured by touching compressor and its peripheral parts which are extremely hot during the operation.

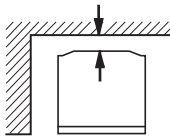

Note

- By keeping greater space, the refrigerator may consume a less amount of power consumption.
- If use the refrigerator in the smaller space dimension than figured, it may cause temperature rise in the unit, loud noise and failure.
- Do not push the refrigerator against the wall. The wall surrounding the refrigerator may get dirty or discolored because of the air flow caused by heat radiation.

Note

- Place your refrigerator to access the plug.
- Keep your refrigerator out of direct sunlight and do not place next to heat generating appliance.
- Do not use shipping materials as a stand. Place the refrigerator on a hard floor, not directly on the earthen floor. In the case of placing the refrigerator on the earthen floor, use an appropriate base such as a wooden board under the refrigerator.

Before using your refrigerator

- Clean the inside parts with a cloth soaked in warm water. If soapy water is used, wipe it off thoroughly with water.
- Remove packing materials (cushion, blue tapes etc.).

Overall space required in use

	SJ-3822M SJ-FTS11BVS	SJ-4122M SJ-4422M SJ-FTS13BVS
a	1073mm	1073mm
b	1254mm	1295mm

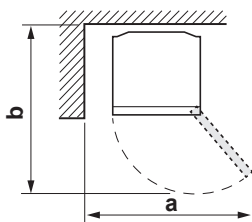

Description

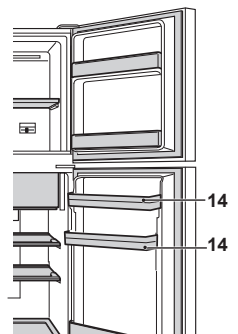
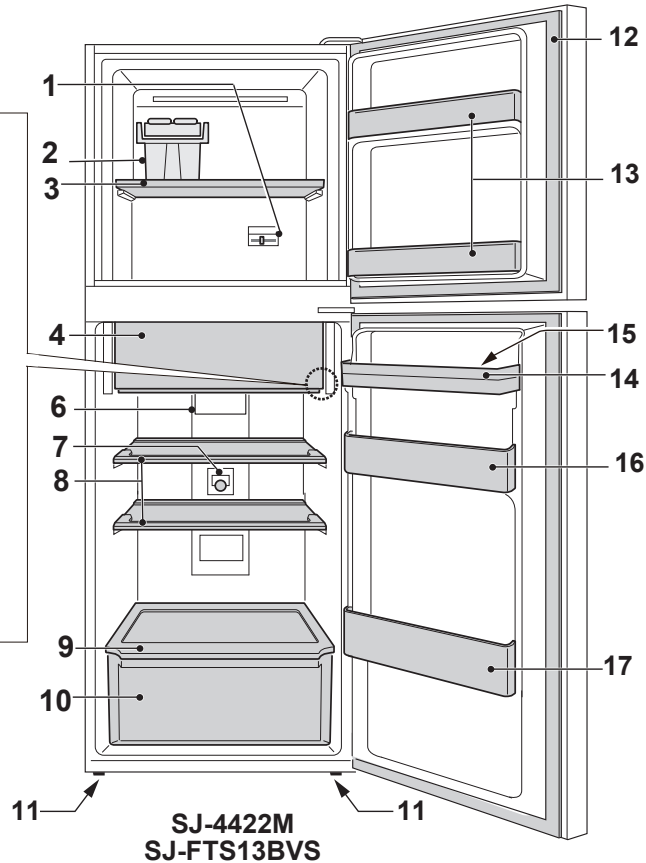
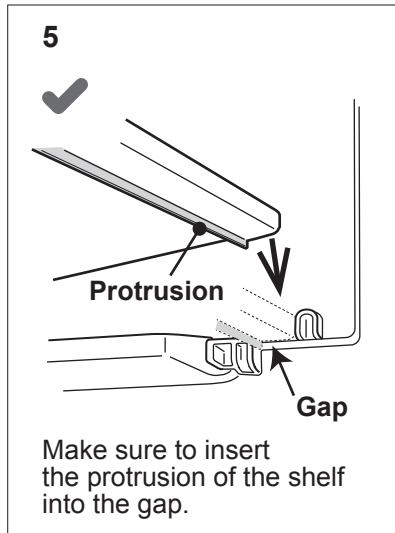

1. Temperature control lever
2. Movable ice maker
3. Freezer shelf
4. Two-way fresh room door
5. Fresh shelf
6. Light
7. Control panel
8. Refrigerator shelf (2 pcs)
9. Vegetable shelf
10. Vegetable case
11. Adjustable foot
12. Magnetic door seal
13. Freezer door pocket

14. Egg pocket

SJ-3822M, SJ-4122M : 2pcs

Note

Food with high-moisture may freeze when Two-way fresh room door is open.

15. Egg tray

16. Refrigerator door pocket (only for SJ-4422M, SJ-FTS13BVS)

17. Bottle pocket

Deodorizing unit

Deodorizing catalyst is installed on the routes of cold air. There is no need to operate and clean.

If you wish to store large items within your refrigerator

- You may remove any shelves or any pockets numbered 2,3,5,8,9,10,13,14,15,16,17 in the picture above.
- Cooling performance is not influenced even if you use the refrigerator in the above situation.

Two-way fresh room door

Open



Use the space as refrigerator room.

Close

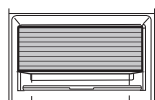

Use the space as fresh room.

How to open Two-way fresh room door

- 1) Lift up the door.
- 2) Insert the door into the frame and push it back to the stopper. It is locked properly.

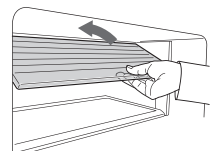

Movable ice maker

It is highly recommended to use the ice maker as shown in the picture of "Description". You can put the ice maker anywhere in the freezer compartment.

- 1) Pour the water into the ice cube tray.

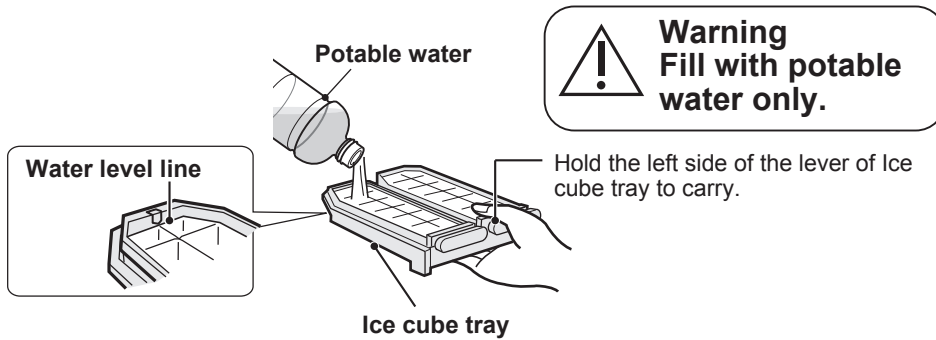

Do not overfill the tray with water. Otherwise the ice cubes will join together when frozen.

- 2) When ice cubes are made, turn the lever clockwise to put the ice into the ice cube box.

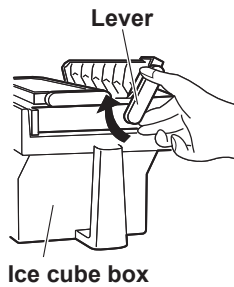

Note

- Make sure to place the ice maker flatly not to spill out the water from the ice tray.
- To prevent the ice cube box from being damaged, do not pour oil into the box or make ice in it.

How to install the spring of the ice cube tray

If the spring of the ice cube tray comes off, follow the instructions below.

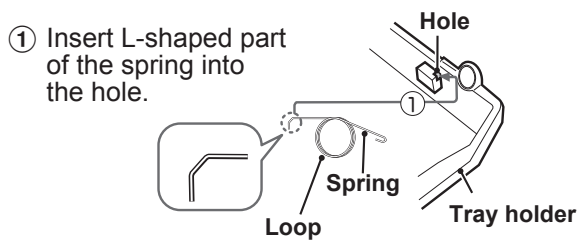

- ④ Fit the lever to the tray holder.

Caution
Be careful not to get injured by the edge of the spring.

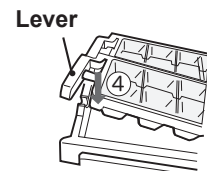

- ② Hook U-shaped part to the ice cube tray.

- ③ Thread the loop through the protrusion and fit the tray holder.

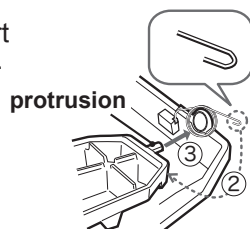

Control panel

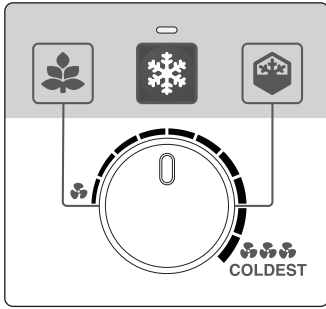

Button	Mode	Default setting
	Express freezing	OFF

Icon	Mode	Default setting
	Energy saving	OFF
	Extra cool plus	
—	Plasmacluster	ON *

* The Plasmacluster operates automatically when the refrigerator is powered on. There is no need to switch on/off.

Plasmacluster

The Plasmacluster automatically starts operating when the refrigerator is powered on.

The ionizer inside your refrigerator releases clusters of ions, which are collective masses of positive and negative ions, into the refrigerator compartment. These ion clusters inactivate airborne mold fungus.

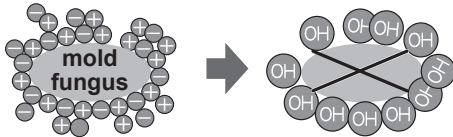

Note

There may be a slight odor in the refrigerator. This is the smell of ozone generated by the ionizer. The amount of ozone is minimum and quickly disappears in the refrigerator.

Express freezing

This mode speeds up the time to freeze food or make ice.

CAUTION

Do not place glass bottles. There is a high risk that they may burst.

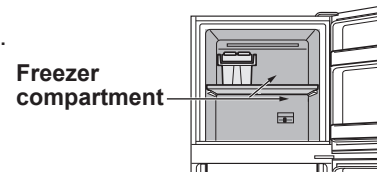

How to start

Press the mode button.



How to cancel

Press the mode button.



- This mode ends automatically.
- Normal operating time is 2 hours. However, it may take more time to complete if the operation overlaps with defrosting. This mode starts after defrosting is completed.
- Avoid opening the freezer door as much as possible during this mode.
- In the event of power outage, this mode is automatically cancelled.

Controlling temperature

Temp. control knob (in the refrigerator compartment)

The default setting of this knob is shown in below picture. This knob is for adjusting the cooling strength of the refrigeration system according to the temperature in the refrigerator compartment.

When the knob is turned to "COLDEST" side, both compartments (refrigerator compartment and freezer compartment) are cooled well.



Temp. control lever (in the freezer compartment)

Set the lever to the center for normal use.

This lever is to open or close the air passage to the refrigerator compartment.

When the lever is slide to "COLDEST" side, only the freezer compartment is cooled well.

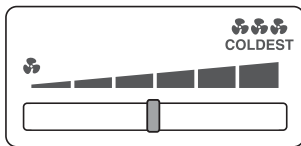

Position of the lever	Condition
Left	<ul style="list-style-type: none"> Cold air flows into the refrigerator compartment more. The refrigerator compartment is cooled well.
Right	<ul style="list-style-type: none"> Cold air flows into the freezer compartment more. The freezer compartment is cooled well.

Recommended temperature settings are shown below.

	Temp. control lever	Temp. control knob
Normal		
In winter (Colder than 10°C)	<ul style="list-style-type: none"> Set to the right. Do not set to left side. 	

Energy saving

Use this mode when you want to switch the refrigerator to energy-saving operation.

While this mode is operating, the inside temperature of the refrigerator and freezer compartment becomes higher than the normal operation as follows.

	Freezer compartment	Refrigerator compartment
Under "Energy saving" mode	Approx. 3°C plus	Approx. 4°C plus

Cancel this mode when you feel the beverages are not cooled enough or ice making takes longer time.

How to start the operation

Turn the knob toward the icon.

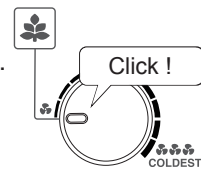

How to cancel the operation

Turn the knob toward the top.

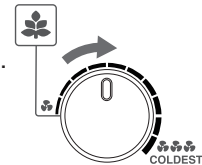

Note

- The efficiency of power saving depends on the usage environment (controlling temperature, ambient temperature, frequency of opening or closing the door, amount of food).

Extra cool plus

This setting is to cool beverages or foods to ice-cold.

CAUTION

Make sure to close two-way fresh room door to use this setting.

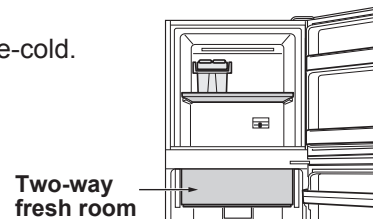

How to start

Turn the knob toward the icon.

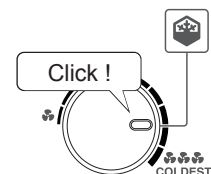

How to cancel

Turn the knob toward the top.

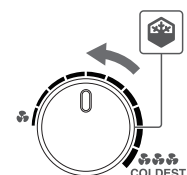

Note

- Food with high-moisture may freeze.
- Avoid opening the refrigerator door as much as possible during this setting.

Storing food

- Ensure that the food is of the freshest possible quality to maximize the storage life of perishable food. The following is a general guide to help promote longer food storage.
- Food has a limited storage life. Make sure not to exceed use-by date indicated by manufacturer.

Fruit / Vegetables

Fruit and vegetables should be loosely enclosed in a plastic material e.g. wrap, bags (do not seal) and placed in the vegetable case to minimize moisture loss.

Dairy Products & Eggs

- Most dairy products have their best-before date on the outer packaging which informs the recommended temperature and shelf life of the foods.
- Eggs should be stored in the Egg pocket.

Meats / Fish / Poultry

- Place on a plate or a dish and cover with paper or plastic wrap.
- For larger cuts of meat, fish, or poultry, place to the rear of the shelves.
- Ensure all cooked food is wrapped securely or placed in an airtight container.

For best freezing

- Quality of foods should be fresh.
- Freeze small quantities of food at a time in order to freeze them quickly.
- Food should be properly sealed or covered tightly.
- Place foods in the freezer evenly.
- Label bags or containers to keep an inventory of freezing food.

*Notes for fresh food

- Fresh food (securely wrapped) should be stored in limited time to prevent spoilage and badly affecting other stored foods.

Advice for preventing dew or frost inside the refrigerator

- Keep the door securely closed. If the food falls down, it may cause a gap between the cabinet and the door. Move it back to the shelf or the pocket.
- Food with high-moisture should be stored in airtight container or sealed tightly.

Advice for storing food

- Evenly place the food on the shelves to allow the cooling air to circulate efficiently.
- Opening the door for long periods can cause a significant increase of the temperature in the compartments of the appliance.
- Hot foods should be cooled before storing. Storing hot foods increases the temperature in the unit and the risk of food spoilage.
- Do not block the outlet and inlet of the cool air circulating circuit with foods or containers; otherwise the foods is not be evenly cooled throughout the refrigerator.
- Do not place food directly in front of cold air outlet. This may lead to the food freezing. air to circulate efficiently.

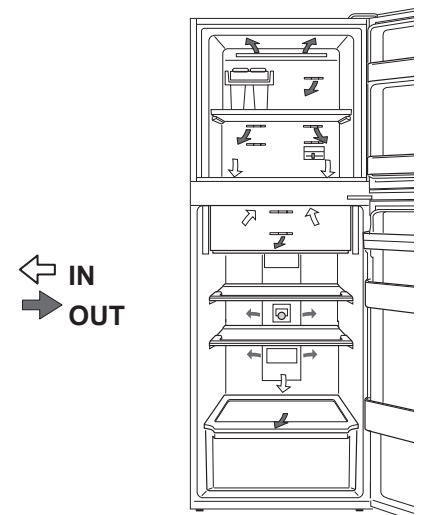

Tips for saving energy

- Install the refrigerator in a well-ventilated area and keep the space to ventilate.
- The amount of energy consumption of this model is measured as shown in the picture below.

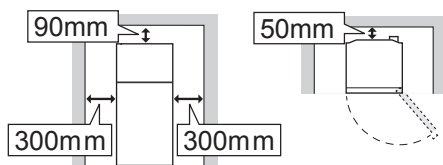

- Keep your refrigerator out of direct sunlight, and do not place it next to heat generating appliance.
- Avoid opening the door as much as possible.
- Hot foods should be cooled before storing.
- Place the food evenly on the shelves to allow the cool air to circulate efficiently.

Care and cleaning

Important

Follow the tips below to prevent cracks on the inner surfaces and plastic components

- Wipe out food oil adhered to plastic parts.
- Some household chemicals may cause damage, so use only diluted washing-up liquid (soapy water).
- If undiluted detergent is used or soapy water is not wiped off thoroughly, it may result in cracks of plastic parts.

Cleaning

For hygienic reasons, make sure to do following things regularly.

- Remove the accessories (e.g. shelves) from the cabinet and the door. Wash them by warm soapy dishwashing water. After that, rinse them in clean water and dry.
- Clean the inside with a cloth soaked in warm soapy dishwashing water. Then, use cold water to wipe off soapy water thoroughly.
- Wipe the exterior with a soft cloth each time it gets dirty.
- Clean the Magnetic door seal with a toothbrush and warm soapy dishwashing water.
- Do not put on the shelf on the protrusions.
- Make sure to put the shelf on the rail.
The hooks of the shelf must be frontside and downward.
If the shelf is not placed correctly, it may fall down.

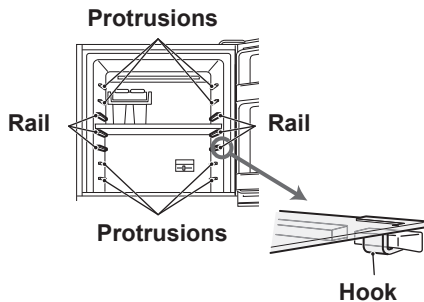

- Do not remove the air inlet of the freezer compartment. If you remove them forcibly, it may cause deformation of the parts.

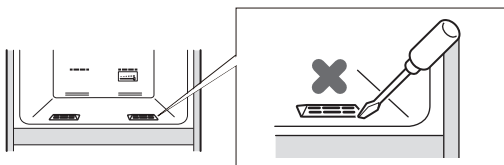

Note

- After cleaning, make sure to put the shelves and the cases on original position.
- Do not use heavy-duty cleansers or solvents (lacquer, paint, polishing powder, benzine, boiled water, etc.) which may cause damages.
- If you pull out the power plug once, wait 5 minutes at least before connecting the power plug again.
- The glass shelves are heavy to carry. Hold them firmly when you remove the shelves from the cabinet.
- Do not drop objects inside the refrigerator or strike the inner wall. This may cause cracks to inner surface.

Defrosting

Defrosting is automatically operated by a unique energy saving system.

When the compartment light is blown

Contact the service agent approved by SHARP to replace the light. The light is not to be replaced other than by qualified service personnel.

Switching off your refrigerator

If the refrigerator needs to be switched off for an extended period, the following steps should be taken to reduce the growth of mold:

1. Remove all food.
2. Remove the power plug from the socket.
3. Clean and dry the interior thoroughly.
4. Keep all the doors open slightly for a few days to dry.

Before you call for service

Before calling for service, check the following points.

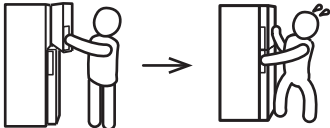
Problem	Solution
The outside of the cabinet is hot when touching.	It is normal. The hot pipe is in the cabinet in order to prevent dew generation.
When there is refrigerator noise.	<p>It is normal for the refrigerator to make the following sounds.</p> <ul style="list-style-type: none"> • Loud noise is made by the compressor when its operation starts <ul style="list-style-type: none"> -- Sound becomes quieter after a while. • The compressor makes loud noise once a day. <ul style="list-style-type: none"> -- Operating sound is made immediately after automatic defrost operation. • Sound of flowing fluid (gurgling sound, fizzing sound) <ul style="list-style-type: none"> -- Sound of refrigerant flowing in pipes (sound may become louder from time to time). • Cracking or crunching sound, squeaking sound <ul style="list-style-type: none"> -- Sound produced by expansion and contraction of inner walls and internal parts during cooling.
Frost or dew appears inside or outside the refrigerator.	<p>This may occur in one of the following cases. Use a wet cloth for wiping frost and a dry cloth for wiping dew.</p> <ul style="list-style-type: none"> • When the ambient humidity is high. • When the door is frequently opened and closed. • When foods containing plenty of moisture are stored. (Wrapping is required.)
The foods in the refrigerator compartment freeze.	<ul style="list-style-type: none"> • Is the refrigerator operated for a long time with the temp. control knob set COLDEST? <ul style="list-style-type: none"> -- Change the temperature control to the other setting. • If ambient temperature is low, foods may freeze even if the the temp. control knob is set at leftmost position.
Odors in the compartment.	<ul style="list-style-type: none"> • Wrapping is required for the foods with strong odors. • Deodorizing unit cannot remove all odors.
The refrigerator door is hard to open.	<p>The refrigerator door may become hard to open right after closing the freezer door, because the air temperature and the pressure inside the refrigerator compartment go down.</p> <p>Please wait for approximately 10-15 seconds to open the refrigerator door.</p> <div style="text-align: center;">  </div>

If you still require service

Refer to your nearest service agent approved by SHARP.



感謝您購買SHARP 產品。在使用SHARP 電冰箱之前，為使您能夠充份使用您所購買的冰箱，請仔細閱讀本使用說明書。

- 本冰箱可用於製作冰塊、冷藏和冷凍食物。
- 本冰箱僅供家庭使用，使用冰箱的環境溫度已在表格中寫明。氣候類型已在標牌上詳細說明。如果冰箱在該型號所定的氣候類型範圍（環境溫度範圍）外運作，可能無法維持符合要求的內部溫度。如在較冷的溫度下使用本冰箱，則溫度在+5°C以內不會損壞冰箱。
- 冰箱在一段長時間內不應受到-10°C或以下的溫度。

僅限於家庭用途

氣候類型	可接受的環境溫度範圍
SN	+10°C ~ 32°C
N	+16°C ~ 32°C
ST	+16°C ~ 38°C
T	+16°C ~ 43°C

安全注意事項

 警告	這表明導致死亡或重傷的風險很高。
 注意	這表明導致材料受損或人員受傷的風險很高。
 注意	火災標誌表示該冰箱存在火災事故的風險。

警告

冷媒種類

本冰箱含有易燃製冷劑（R600a：異丁烷）和絕熱發泡氣體（環戊烷）。

為防止著火和爆炸，請遵守以下規則。

- 不要讓任何尖狀物體接觸製冷系統。冰箱後側及內部的制冷系統含有冷媒。
- 請勿使用機械設備或其他方式來加速除霜過程。（此冰箱已採用自動除霜系統。）
- 請勿在冰箱內使用電器。
- 請勿堵塞冰箱周圍的空間。
- 請勿在冰箱附近使用易燃性噴霧劑，例如噴漆，否則可能會導致爆炸或火災。
- 如果冰箱的冷卻系統出現故障，請勿接觸牆壁電源插座，也勿使用明火。
- 如果冰箱的冷卻系統出現故障，請勿接觸牆壁電源插座，也勿使用明火。開啟窗戶，保持空氣流通。然後聯繫SHARP認可的售後服務中心進行維修。

電源線，插頭，插座

為防止觸電或火災，請仔細閱讀以下規則。

- 確保在安裝或移動過程中保護電源纜線不受損壞。如果電源插頭或電源線出現鬆動等情況，請勿插入電源插頭。
- 請勿在冰箱後部放置多個移動式插座或移動式電源供應器。
- 直接將電源插頭牢牢地插入牆壁電源插座。請勿使用延長的電線或轉換插頭。
- 將電源插頭插入符合額定電壓要求的插座上。
- 正確地將接地棒連接到接地端子。
- 請勿用濕手接觸電源插頭。
- 拔出電源插頭時，應該握住插頭端拔出。請不要只拉住電源線。
- 電源插頭上積滿灰塵是引起火災的原因。因此，請時常將其擦淨。

- 冰箱如果長時間不使用，請將插頭拔出。
- 若可彎曲纜線損壞，必須由 SHARP 批准的服務代理人更換纜線。

安裝

- 請勿將冰箱設置在濕氣多及濺得到水的地方。這樣會因絕緣失效而導致漏電。而且有時會在冰箱外側結露。
- 將冰箱穩妥地安裝在地板的水平位置上。

使用中

- 請勿儲藏揮發性物質和易燃性物質，如乙醚、汽油、丙烷氧、粘合劑、純乙醇等。此類物質有爆炸之危險。
- 請勿在冰箱內儲存溫度敏感型產品，例如醫藥產品。否則產品極可能會變質。
- 請勿嘗試變更或改裝本冰箱。這可能導致火災、觸電或受傷。
- 請勿將瓶裝或罐裝飲料放入冷凍室。特別是「快速冷凍」功能開啟時，玻璃瓶極可能會爆裂。
- 請勿在冰箱頂部放置任何物品。如果物品從冰箱頂部掉落，可能會導致人員受傷。
- 此冰箱適合 8 歲及以上的兒童使用。在有符合電器使用安全的監督或指導及了解潛在危險的前提下，此冰箱也適合身體、感官或智力方面有缺陷的殘障人士、或者缺乏相關經驗或知識的人士使用。禁止讓兒童玩耍冰箱。在無任何監督的情況下，兒童不得對冰箱進行清潔及維修保養。

保養

- 為了防止觸電，首先拔掉冰箱的電源插頭。
- 請勿直接將水灑在冰箱的內部和外部。這樣會導致生鏽及絕緣性能下降。

故障

- 如果您聞到有東西燒焦了，則立即拔出電源插頭。然後聯繫SHARP認可的售後服務中心進行維修。
- 萬一發生瓦斯洩漏事故，請打開窗戶通風。請勿觸碰冰箱或電源插座。

注意

運輸

- 安裝或移動冰箱時，請使用防護墊以防止地板受損。
- 安全搬運冰箱。
如果抬起冰箱的方式不當，可能會導致人員受傷。

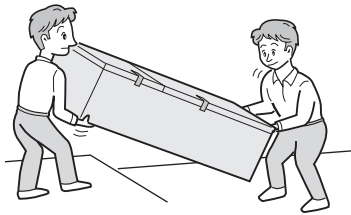

- 搬運冰箱時請勿握住冰箱門。



- 在安裝或移動冰箱前，請確保先聯絡特約維修中心。

廢舊冰箱的處理

- 確保冰箱在存放時不會對兒童造成危險，直致丟棄為止。（例如，卸下冰箱門環，防止兒童陷入困境。）
- 請妥善處理冰箱。冰箱請運送至專業的可燃性製冷劑及絕熱發泡氣體廢料處理廠。

使用中

- 由於壓縮機單元或者其外圍部件在操作過程中將變得非常燙手，千萬不要去觸摸，否則，將會被金屬邊緣燙傷。
- 不要用濕手去觸摸冷凍室內的食品 and 金屬製容器。恐會導致手凍傷。
- 請勿用飲用水以外的水製作冰塊。
- 請勿將瓶裝或罐裝飲料放入冷凍室。
- 在有人將手放在冰箱門附近時，請勿開關門。存在其他人可能會被冰箱門夾住手指的風險。
- 請勿在冰箱門的冰箱盒上放置尺寸過大的物品。如果該物品從冰箱盒上掉落，可能會導致人員受傷。
- 確保在安裝或拆除玻璃層架時要謹慎處理玻璃層架。如果您放下玻璃層架，它可能會破裂或造成傷害。

- 1** 冰箱的周圍應確保足夠的通風空間。
此圖顯示了安裝冰箱所需的最小空間。在不同的空間尺寸下進行能源消耗測量條件。

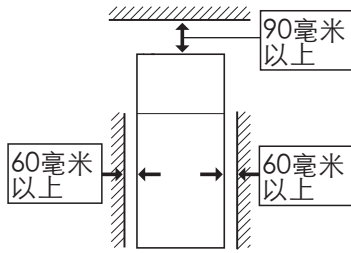

後部淨空

冰箱後部與牆體之間的空间距離應為大於50mm 且小於75mm。若此空間大於75mm，切勿觸摸在運行中過熱的壓縮機以及外圍部件，以免受傷。

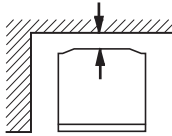

請注意

- 冰箱周圍的空間越大，冰箱運行時的耗電量越小。
- 如果在小於如圖所示的空間尺寸中使用冰箱，可能會導致裝置溫度升高、噪音大及故障。
- 請勿將冰箱靠牆推。冰箱周圍的牆壁可能會因熱輻射引起的氣流而變髒或變色。

使用時所需總體空間

	SJ-3822M SJ-FTS11BVS	SJ-4122M SJ-4422M SJ-FTS13BVS
a	1073mm	1073mm
b	1254mm	1295mm

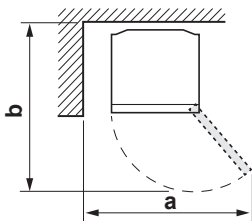

- 2** 請利用調整腳，將冰箱平穩地放在地板上。

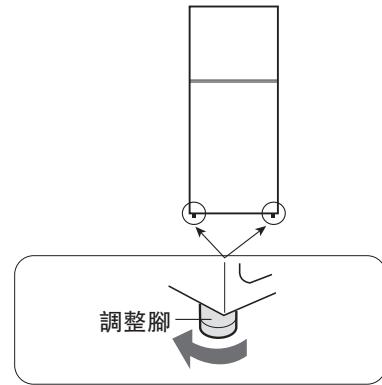

請注意

- 設置冰箱時要充分考慮便於插拔插銷。
- 請勿將冰箱放在陽光直射的地方或發熱機器的旁邊。
- 請勿把運輸材料用作支架。
把冰箱放在堅硬的地板上，而不是直接放在泥土地板上。
如果將冰箱放在泥土地板上，請在冰箱下方使用合適的底座，如木板。

在使用冰箱前

- 用溫水浸泡過的軟布清潔冰箱內部。
如果使用肥皂液，請用水徹底擦掉殘留肥皂液。
- 拆卸包裝材料（襯墊、藍色膠帶等）。

各部位名稱

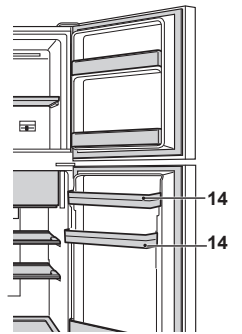
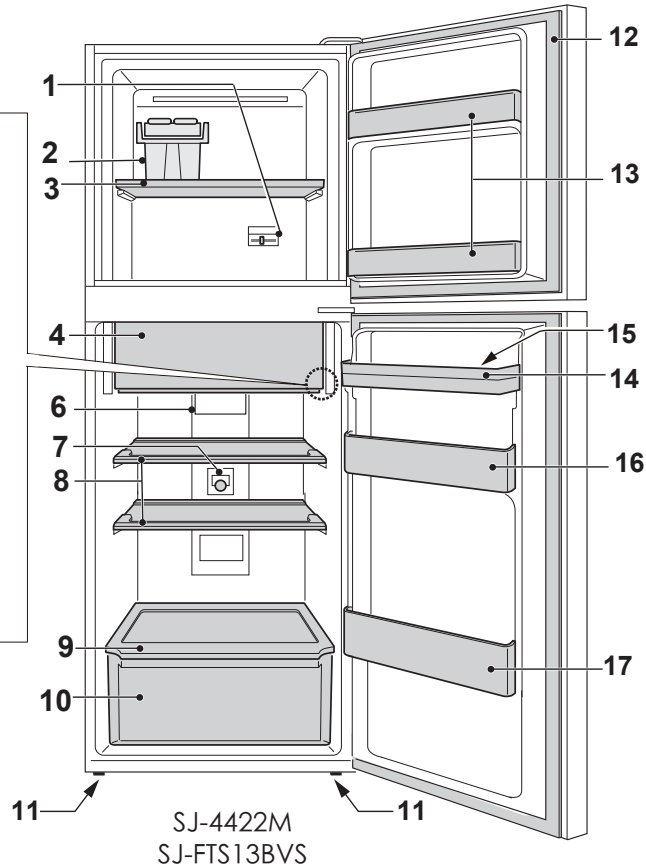
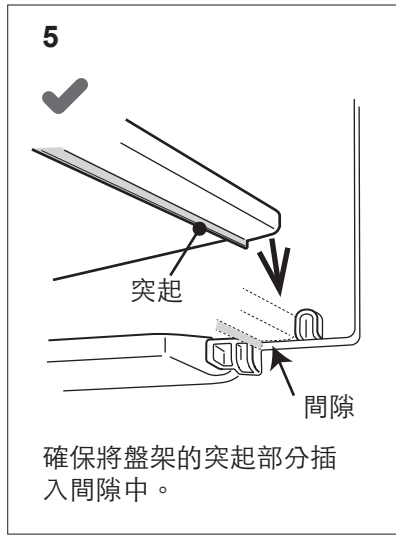

1. 溫度控制桿
2. 可移動的製冰機
3. 冷凍室盤架
4. 兩用冰溫室門
5. 保鮮室盤架
6. 冷藏室箱內燈
7. 控制面板
8. 冷藏室盤架 (2個)
9. 蔬果盤架
10. 蔬果盒
11. 調整腳
12. 門環
13. 冷凍室門盒

14. 蛋盒
SJ-3822M, SJ-4122M : 2個
請注意
兩用冰溫室門開啟時，水分含量高的食物可能會結冰。
15. 蛋架
16. 冷藏室門盒 (僅適用於 SJ-4422M, SJ-FTS13BVS)
17. 瓶盒

脫臭裝置

已經將脫臭觸媒設置在冷氣的通道上。不需要進行操作和清潔。

如果要在冰箱內儲存大型物品

- 您可能要卸下上圖中編號 1, 2, 3, 4, 5, 6, 7, 8, 12, 13, 14, 15, 16 的任何層架或任何貯藏器。
- 即使您在以上情景中使用冰箱，其冷卻效能不受影響。

兩用冰溫室門

開



將空間用作冷藏室。

關

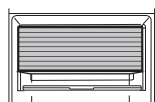

將空間用作冰溫室。

如何打開兩用冰溫室門

- 1) 抬起冰溫室門。
- 2) 將冰溫室門卡入門框中，然後向後推到擋板處。其將正確地鎖定到位。

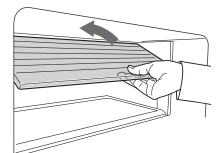

可移動的製冰機

強烈建議使用「說明」圖片中所示的製冰機。
您可以在冷凍室中的任何位置放入製冰機。

1) 將水倒入製冰格中。

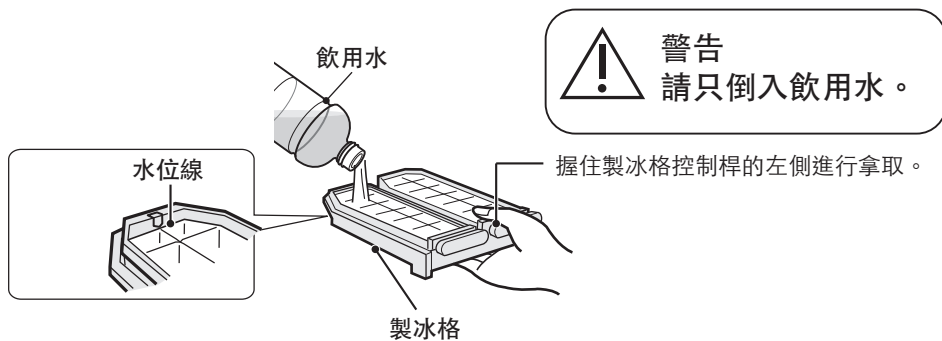

請勿在冰格中裝滿水。
否則，製成的冰會連結在一起。

2) 冰製成以後，請按順時針方向轉動控制桿，將冰倒進儲冰盒內。

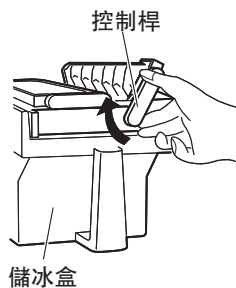

請注意

- 務必要將製冰機平放，使水不要從冰格中溢出。
- 為了防止儲冰盒受損，請勿在其中倒入油或用於製冰。

如何安裝製冰格的彈簧

如果製冰格的彈簧脫落，請按照以下說明進行操作。

① 將彈簧的 L 形部分插入孔中。

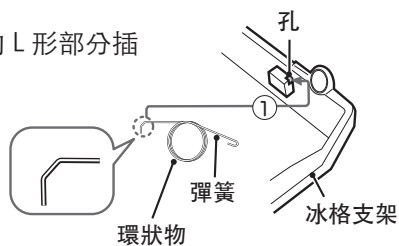

② 將 U 形部分掛在製冰格上。

③ 將環狀物穿過突起部分，並裝上冰格支架。

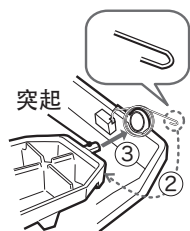

④ 將控制桿安裝到冰格支架上。

注意
小心別被彈簧邊緣弄傷。

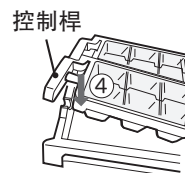

控制面板

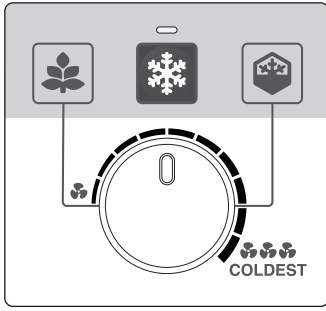

按鈕	模式	默認設置
	快速冷凍	關閉

圖標	模式	默認設置
	節約能源	關閉
	加倍強力製冷	
—	淨離子群	開 *

* 當冰箱通電時，淨離子群會自動運行。不需要開啟/關閉。

淨離子群

當冰箱通電時，淨離子群會自動開始運行。冰箱內的離子產生器將向冷藏室釋放出淨離子群。淨離子群是正離子和負離子的集合體。淨離子群能不活潑空氣中浮遊黴菌。

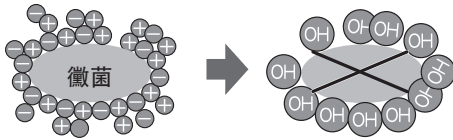

請注意

冰箱內可能有異味。這是離子發生器產生的臭氧的味道。臭氧密度非常小，釋放到冰箱內的臭氧會迅速分解。

❄️ 快速冷凍

可以用本功能加速冷凍食品或製造冰塊。

注意

請勿放置玻璃瓶。
玻璃瓶極可能會爆裂。

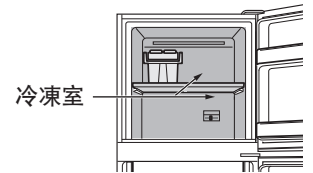

如何開始

按下功能按鈕。



如何取消

按下功能按鈕。



- 本功能會自動結束。
- 正常運行時間為 2 小時。
然而，當本操作與除霜功能重疊時，可能會更費時。因為本功能要在除霜之後啟動。
- 在本模式下，儘量避免打開冷凍室門。
- 在停電的情況下，本模式會自動取消。

實用功能

溫度控制旋鈕 (位於冷藏室內)

該旋鈕的預設設定如下圖所示。該旋鈕的作用是根據冷藏室的溫度調節製冷系統的冷卻強度。
當旋鈕轉到「COLDEST」側時，兩個儲藏室（冷藏室和冷凍室）均冷卻良好。

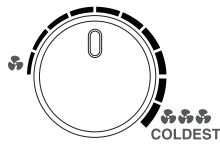

溫度控制桿 (位於冷凍室內)

將控制桿調至中間，以供正常使用。
該控制桿用於開關通向冷藏室的空氣通道。
當控制桿滑到「COLDEST」側時，只有冷凍室冷卻良好。

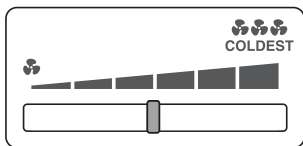

控制桿的位置	條件
左側	<ul style="list-style-type: none"> 進入冷藏室的冷氣量更多。 冷藏室冷卻良好。
右側	<ul style="list-style-type: none"> 進入冷凍室的冷氣量更多。 冷凍室冷卻良好。

建議的溫度設定如下所示。

	溫度控制桿	溫度控制旋鈕
正常		
在冬季 (低於 10°C)	<ul style="list-style-type: none"> 設定在右側。 請勿設定在左側。 	

節約能源

想將冰箱切換為節約能源的運轉狀態時，請使用該模式。
本功能運行時，冷藏室和冷凍室的溫度會高於以下當溫度為預設的常規操作。

	冷凍室	冷藏室
在「節約能源」模式下	上升大約 3°C	上升大約 4°C

如果覺得飲料不夠冰涼或製冰太費時，可取消此功能。

如何啟動操作



如何取消操作



請注意

- 節能效率取決於使用環境（周圍溫度，開關冰箱門的頻率，食物總量）。

加倍強力製冷

本設定旨在將飲料或食品冷卻至冰冷狀態。

注意

確保關閉兩用冰溫室門以使用此設定。

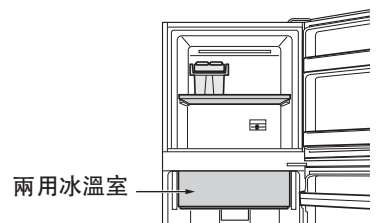

如何開始



如何取消



請注意

- 水分含量高的食物可能會結冰。
- 在此設定期間，儘量避免打開冰箱門。

食品的儲存

- 確保食品維持最新鮮的品質，以使易腐食品的保存期限最大化。下列為幫助延長食品儲存的一般指南。
- 食品的儲存時間有限。確保不超過製造商指示的保存期限。

水果／蔬菜

為儘量減少水分的流失，水果和蔬菜要用保鮮紙及袋子(不封口)之類的塑膠袋輕輕包上，並將其放入蔬果盒內。

乳製品和雞蛋

- 幾乎所有乳製品的外包裝上都標有適當的保存溫度和保存期限。
- 請用蛋盒存放雞蛋。

肉類／魚／禽肉

- 請將其放在容器上，並包上保鮮膜。
- 若是大塊的肉、魚和禽肉，請將其放在盤架的內側。
- 已經煮熟的食品務須用保鮮膜包好，或將其放在密封容器內。

為達到最佳冷凍效果

- 食品品質應當新鮮。
- 若要快速冷凍食品，每次都必須少量放入。
- 食品應進行恰當密封，要封緊或蓋緊。
- 將食品均勻地放入冷凍室。
- 袋子和容器上要標上標示，並寫清楚冷凍食品的內容。

*針對新鮮食品之注意事項

- 新鮮食品（安全包裝）應儲存有限時間，以防變質並嚴重影響其他儲存的食品。

節約能量的竅門

- 把冰箱安裝在通風良好的地方，並保持通風。
- 此模型的能源消耗量如下圖所示測量。

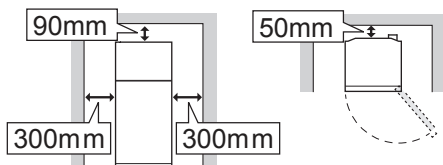

- 請勿將冰箱放在陽光直射的地方或發熱機器的旁邊。
- 盡量避免開門。
- 請將較熱的食品涼下來以後，才保存起來。
- 為使冷氣充分循環，請將食品均勻地放在盤架上。

防止冰箱內部結水珠或結霜的建議

- 使門緊密關上。如果食品落下，可能導致冰箱與冰箱門之前有縫隙。將其放回層架或門盒中。
- 水分含量高的食品應存放在密閉容器中或密封保存。

建議儲存食物

- 為使冷氣充分循環，請將食品均勻地放在盤架上。
- 冰箱門長時間開啟可能會造成電器內部空間溫度明顯升高。
- 請將較熱的食品涼下來以後，才保存起來。如果將較熱的食品放進冰箱，冰箱內的溫度會升高，這樣往往很容易導致食品腐爛變質。
- 請勿讓食品和容器擋住使冷氣循環的出風口和吸入口。否則，食品就不能均勻地冷卻。否則，食品就不能均勻地冷卻。
- 請勿直接將食品放在冷氣出風口旁。這樣會引致食品結冰。

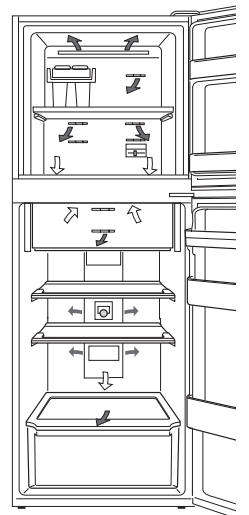

保養

重要提示

遵循下面貼士，防止內部表面與塑膠元件出現裂痕

- 食用油沾上塑膠部件時，請將之擦掉。
- 某些家用化學洗滌劑可能會導致冰箱損傷，因而只能使用稀釋過的廚房用洗滌劑（肥皂水）。
- 如果使用未稀釋的洗劑或者未徹底擦淨肥皂水，則有可能損壞冰箱的塑膠部件。

清潔

出於衛生理由，請確保定期進行以下操作。

- 拆下冰箱櫃體（如盤架）和門上的附件。用溫水和廚房用洗滌劑清洗。然後，用水洗清並使之乾透。
- 用浸泡廚房用洗滌劑的溫水中的軟布清潔冰箱內部。接著使用冷水徹底擦除洗滌水。
- 冰箱的外殼沾上污漬時，請用柔軟的布塊擦洗。
- 冰箱門環要用廚房用洗滌劑的溫水和牙刷洗淨。
- 不要放在盤架的突起部分上。
- 確保將盤架放在滑軌上。
盤架的掛鉤必須正面朝下。
如果盤架放置不當，它可能會掉落。

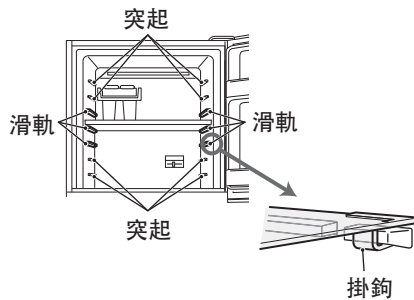

- 不要拆除冷凍室的進氣口。
若強行拆除，則可能會導致零件變形。

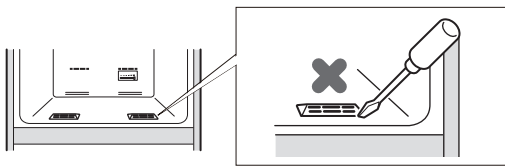

請注意

- 清潔之後，請確保將盤架和收納盒放在原本的位置上。
- 請勿使用強力清潔劑或溶劑（油漆、塗料、拋光粉、汽油、沸水等），否則可能導致冰箱損傷。
- 一旦拔出電源插頭，請等待至少5分鐘之後再重新接通電源。
- 玻璃層架很重，不易搬運。當您從冰箱拆卸層架時，請牢牢抓住。
- 在冰箱內請勿使物體掉落，或用物體強烈碰撞內壁。否則可能導致內壁破裂。

除霜

本冰箱透過獨特的節約能源系統，完全實現自動除霜。

當冷藏室內燈損壞時

請聯繫SHARP 認可的售後服務中心更換內燈。非專業服務人員不得更換內燈。

切斷冰箱的電源時

如果冰箱需要長時間關閉，則應採取以下步驟以減少黴菌生長：

1. 拿出所有食物。
2. 從插座處拔除電源插頭。
3. 徹底清潔並乾燥內部區域。
4. 保持所有冰箱門稍微開放幾天進行乾燥。

送修之前的初步檢查

送修之前，請對下列地方進行檢查。

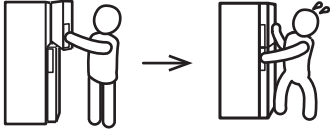
問題	對策
冰箱外箱有時會變熱。	這並非異常。熱管位於冰箱櫃體內，以防止結露。
冰箱發出噪音時。	冰箱如發出以下聲音，這並非異常。 <ul style="list-style-type: none">• 壓縮機運轉開始時會發出較大的噪音<ul style="list-style-type: none">-- 不久聲音會變小。• 壓縮機每日一次發出較大噪音。<ul style="list-style-type: none">-- 在自動除霜作業之後，立即會發出運作聲音。• 液體流動的聲音（咕嚕聲、嘶嘶聲）<ul style="list-style-type: none">-- 冷媒在管道中流動的聲音（聲音時而會變得較大）。• 劈啪聲或吱嘎聲，吱吱聲<ul style="list-style-type: none">-- 冷卻時內壁和內部零件膨脹和收縮產生的聲音。
冰箱內部和冰箱外側結霜或結露。	在下列情形下有可能發生這種現象。請用濕布擦掉霜，用乾布擦掉露珠。 <ul style="list-style-type: none">• 周圍溫度較高時。• 頻繁開啟冰箱門時。• 冰箱內存放水分較多的食品時（請用保鮮膜包上）
冷凍室內的食物被冰凍。	<ul style="list-style-type: none">• 是否長期在溫度控制旋鈕設為 COLDEST 的狀態下使用冰箱？<ul style="list-style-type: none">-- 將溫度調節設定改為其他設定。• 在環境溫度較低時，即使將溫度控制旋鈕設定為最左側位置，食品也可能會結冰。
冰箱內部有異味。	<ul style="list-style-type: none">• 請將氣味較強的食品用保鮮紙包起來。• 脫臭裝置不能去掉所有異味。
冰箱門很難打開。	剛關上冷凍室門後，可能難以打開冰箱門，這是因為冷藏室內的氣溫和壓力會下降。請等待大約 10-15 秒後再打開冰箱門。 

經檢查後仍需要送修時

請與就近的SHARP認可的售後服務中心洽詢。

SHARP

SHARP CORPORATION