

SHARP®

VACUUM CLEANER

OPERATION MANUAL

EC-C1219-S

Thank you very much for buying SHARP.
Before using your SHARP vacuum cleaner, please read this operation manual carefully to obtain the best use from your vacuum cleaner.

WARNING /

To reduce the risk of fire, electric shock or injury:

- 1 Electric shock could occur if used outdoors or on wet surfaces.
 - 2 Do not leave appliance unattended when plugged in, unplug from an outlet when not in use and before user-maintenance.
 - 3 Close attention is necessary when used by or near children. Do not allow appliance to be used as a toy.
 - 4 Use only for intended use as described in this manual. Use only the manufacturer's recommended accessories and dust cup.
 - 5 Never operate this vacuum cleaner if it has a damaged cord or plug, if it is not working properly, if it has been dropped, damaged, exposed to weather or dropped into water. Return the vacuum cleaner to a Sharp Authorized Servicer for examination and repair.
 - 6 Do not pull or carry this vacuum cleaner by the power cord. Do not use the power cord as a handle, close a door on the cord, or pull the cord around sharp edges or corners. Keep the cord away from heated surfaces. Do not run this vacuum cleaner over the cord.
 - 7 Never disconnect the plug by pulling the cord. To disconnect from an outlet, grasp the plug, not the cord.
 - 8 Never operate this vacuum cleaner with any air opening blocked. Keep the air openings free of dust, lint, hair or any other similar material. When the filter cotton becomes dirty, rinse in lukewarm water. The filter should be completely dry before reusing.
 - 9 Never drop or insert any object into any opening.
 - 10 Keep hair, face, fingers or loose clothing away from any inlet, such as all moving parts.
 - 11 Do not pick up lit cigarettes, hot ashes, matches or similar materials, razor blades, needles, pins or other sharp objects. Do not suck water or any other liquid.
 - 12 Never operate this vacuum cleaner without the dust cup .
 - 13 Before removing the plug from an outlet, switch off the power socket.
 - 14 Pay extra caution when cleaning on stairs.
 - 15 Never handle the plug, cord or vacuum cleaner with wet hands.
 - 16 Do not use in presence of flammable or combustible liquids or fumes.
 - 17 Do not place heavy objects on the vacuum cleaner.
 - 18 Do not pick up large objects such as wasted paper or cloth which may clog the hose.
 - 19 Do not expose this vacuum cleaner to high temperature while operating or during storage.
 - 20 Store the vacuum cleaner in a dry place.
 - 21 Use the carrying handle of the body to carry the vacuum cleaner.
 - 22 The appliance is not to be used by persons (including children) with reduced physical, sensory or mental capabilities, or lack of experience and knowledge, unless they have been given supervision or instruction.
 - 23 Children being supervised not to play with the appliance.
 - 24 The appliance is only to be used with the unit provided.
 - 25 This appliance can be used by children aged from 8 years and above and persons with reduced physical, sensory or mental capabilities or lack of experience and knowledge if they have been given supervision or instruction concerning use of the appliance in a safe way and understand the hazards involved.
 - 26 Cleaning and user maintenance shall not be made by children without supervision.
- Caution : If the cord of this appliances is damaged, it must only be replaced by the repair shop appointed by SHARP in order to avoid hazard.

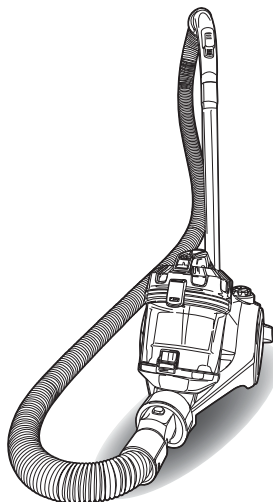

SAVE THESE INSTRUCTIONS

This vacuum cleaner is intended for household use only.

WARNING

Operate this vacuum cleaner only at the voltage specified on the name plate.

PRODUCT VIEW

 Do not plug in your cleaner until you have completely assembled it per the following instructions and are familiar with all instructions and operating procedures.

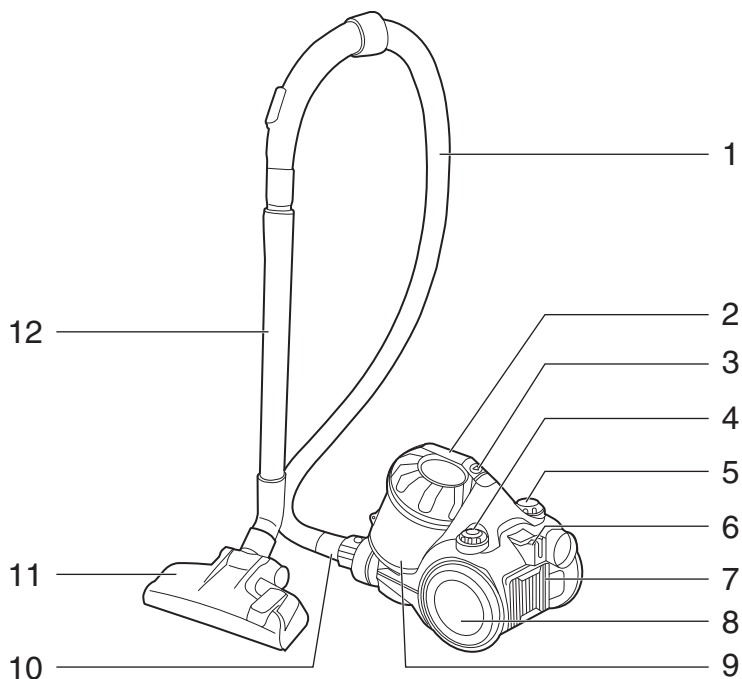

- | | | | |
|---|-------------------------|----|------------------|
| 1 | Hose | 8 | Rubber Wheel |
| 2 | Handle | 9 | Dust Cup |
| 3 | Dust Cup Release Button | 10 | Hose Connector |
| 4 | On/Off Button | 11 | Floor Nozzle |
| 5 | Cord Rewind Button | 12 | Extension Tube |
| 6 | Standing Hook | 13 | 2-ways Nozzle |
| 7 | Air Outlet Cover | | a. Crevice Tool |
| | | | b. Dusting Brush |

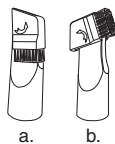

OPERATION METHODS

- 1** Put the hose connector in front of the vacuum cleaner. Then insert it into the inlet hole. To remove it, you can press the release button and then pull it out.

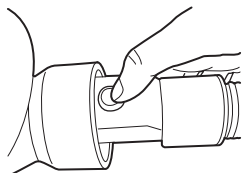

- 2** Connect the extension tube to the curved end of the hose.



- 3** Connect floor brush to the tube for cleaning: floor brush (adjusted to the type of ground) for carpet or hard floor.

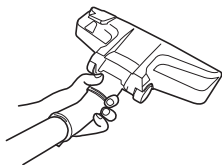

- 4** Turn on the machine: insert the plug and cord into the power socket and press the on/off button, the machine could start working.

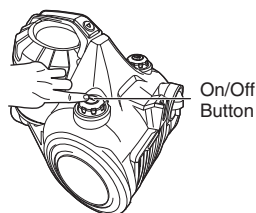

- 5** Move the machine: use the handle on the top of vacuum.

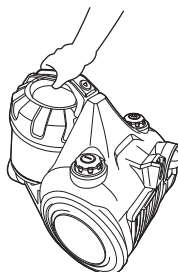

6

Cord rewinding: hold the plug and pull out the cord; press the cord rewind button, the power cord will be drawn in.

- Do not draw out the power cord beyond the yellow mark limit. (max. approx. 5.3m)
- When you cannot roll up the cord completely, draw it out again for a length of 1 to 2 m and attempt to roll it up again.

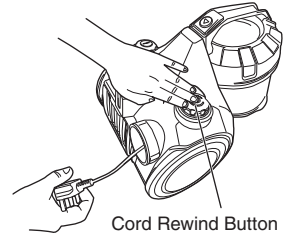

Cord Rewind Button

7

Use of accessory

Dusting Brush

For whisk off dust in fabric such as curtains, blinds, and sofas.



Crevice Tool

For narrow gap and difficult-to-reach corner.



8

Floor Nozzle

For vacuum hard flooring.



For vacuum carpets and rugs.



Tips:

- Before cleaning under low furniture, check the area first for objects that might harm the unit or block the hose.
- Hair, string and small objects can block the hose and tools. Check them occasionally for obstructions.
- Use the air flow regulator to reduce air flow as needed when using the tools.
- For maximum cleaning performance, check the filters often and clean or replace if necessary.

MAINTENANCE

Unplug the vacuum cleaner from an electrical outlet before maintenance.

EMPTY THE DUST CUP

1 Take the dust cup out of the unit.

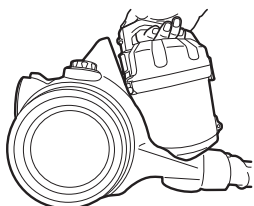

2 Hold the handle and press the dust cup release button.

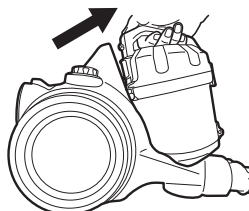

3 Hold dust cup over a rubbish bin and press the dust dispose button to release dust from dust cup. After cleaning, close the bottom lid firmly with a click sound.

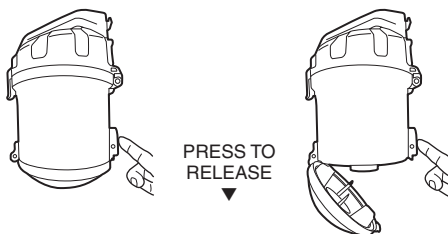

CLEANING FOR ACCESSORIES

Floor Nozzle

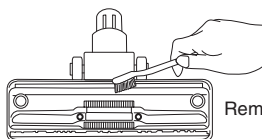

Remove dust with the brush

FILTER MAINTENANCE

Outlet Filter

1 Lift the outlet lock to open the outlet filter cover.

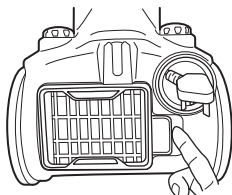

2 Get out the HEPA filter. Wash it and install it after dry.

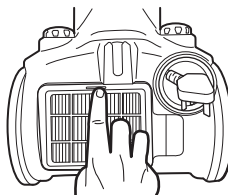

Inlet Filter And Dust Cup

1 Open the dust cup lid.

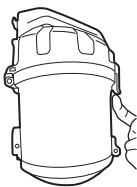

2 Take out the MIF filter and cyclone unit.

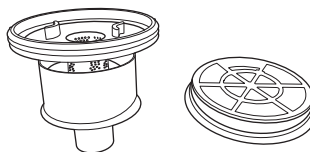

3 Wash cyclone unit and MIF filter with water only. Install it back after dry.

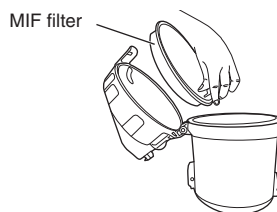
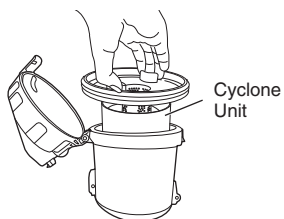



CAUTION

- The plug must be removed from the socket outlet before cleaning or maintaining the appliance.
- **IMPORTANT:** Before re-installing the washable filter, make sure they are completely dry to avoid damaging the cleaner.

Note

- To avoid damaging the motor, never use a broken dust cup, or operate the vacuum cleaner without the dust cup.
- To keep the suction power highly efficient and lengthen a life of motor, please dispose dust frequently.
- Do not bend, pull and step on the hose, or put anything heavy on the hose.
- Wash the HEPA filter, MIF filter, cyclone, and dust cup using water without detergent. Dry them completely before use.
- Install the dust cup onto the main body. By hearing a clicking sound, it means it is lock safely.

BEFORE ASKING FOR SERVICE

If you experience any difficulties with your vacuum cleaner, use this Troubleshooting Chart first before requesting service.

NOTE : Always remember to have the vacuum cleaner turned OFF and disconnect the plug from an electrical outlet before working on the vacuum cleaner.

TROUBLESHOOTING CHART

Problem	Check	Countermeasure
The cleaner does not work.	Check that the appliance is correctly plugged into an electrical outlet.	In case that the thermal cut-off device has operated, wait until it resets after approximately 60 minutes.
		The appliance may be damaged, please take it to an Authorized Service Centre for repair.
The suction performance reduces.	Check if the suction hose, extension pipes or floor nozzle is clogged.	Remove any foreign object that may have clogged in the floor nozzle, hose or pipe.
	Check if the dust cup is filled with dust.	Dispose dust.
	Check if the filter is blocked with dust.	If it is blocked with dust, please clean up the filter.

WARNING

This vacuum cleaner contains a motor protection system to maximize the motor lifespan. It is designed to shut off to avoid overheating in case of a blockage or clogged filter. If the protection device is activated, the vacuum cleaner stops without turning off the switch. If this happens, turn off and unplug the vacuum cleaner.
Please empty the dust cup and clean the inlet filter.
After approximately 1 hour, the motor will have cooled and the vacuum cleaner will be ready to use. Operating this vacuum cleaner with clogged or dirty filter may cause the vacuum cleaner to overheat.
Please clean the inlet filter and empty the dust cup regularly.

Please request service if the problem still persists or if the problem is not defined in the Troubleshooting Chart.

SPECIFICATION

Model	EC-C1219-S
Voltage/Frequency	220-240V/50-60Hz
Motor Max. Power	1200 W
Suction Power	≥190 W
Noise Level	≤81dB (A)
Filter	HEPA Filter
Dust Capacity	1.5 L
Estension Wand	Metal Telescopic
Cord Length	5.3 m
Net Dimension (LxWxH)	360x247x305 mm
Net Weight	4.8 kg
Body Colour	Silver

SHARP[®]
SHARP CORPORATION