



SHARP
SHARP CORPORATION
OSAKA, JAPAN

Operation manual of full-automatic washing machine

自动洗衣机使用说明书

ES-U106H
ES-U906H

Operation manual 使用说明书

Thank you for purchasing our product.
承蒙您购买此本公司产品深表谢意。

Please read this manual carefully before use.
Please read "Safety Precautions" carefully before use.
Please keep this manual in a safe place.
Our product is specially designed for household use only.

请在使用前务必阅读本说明书。
请在使用前务必仔细阅读“安全注意事项”。
请在使用后将本说明书存放在安全的地方。
本公司产品是特别为家庭用户而设计的。

Table of contents 目录	Page 页次
● Safety precautions ----- 2 安全注意事项	2
● Name of each component ----- 6 各个部分零件名称	6
● Key points of washing ----- 7 洗涤重点	7
● Instruction on control panel functions --- 8 操作面板功能说明	8
● Things to know before washing ----- 12 洗涤前须知事项	12
● Instruction on washing courses ----- 13 洗涤程序指南	13
● Self-decided washing course ----- 14 自选洗涤程序	14
● Additional operating procedure ----- 15 其他操作程式	15
● Maintenance ----- 17 产品保养	17
● Common non-fault phenomenon ----- 19 常见的非故障现象	19
● Specifications ----- 23 产品规格	23

Safety precautions

⚠ WARNING

Do not allow children to play with or look around the washing / spin drying tub, in case of injury.



FORBIDDEN

Clothing stained with harmful diluting agents such as gasoline, kerosene and so on must not be put into the washing / spin drying tub.



FORBIDDEN
INFLAMMABLES
GASOLINE

Do not use power supply other than AC220-240V, 50Hz, so as to avoid malfunction, damage and fire.



FORBIDDEN

Except professional repair-men, do not modify the machine. Please do not disassemble and repair the machine without permission, so as to avoid fire, electric shock, getting hurt or malfunctions of the machine.



FORBIDDEN
DISASSEMBLE

Do not place the machine at high-humidity places such as bathroom, locations where wind and rain may get in, and so on. Otherwise, electric shock, fire, malfunctions and distortion may take place.



FORBIDDEN TO
USE AT
HIGH-HUMIDITY
LOCATIONS

Use plug socket above 13A separately. A loose plug socket or the action of sharing a plug socket with other apparatus may start a fire due to heat.



MANDATORY

While cleaning the machine body, the plug should be pulled out first. Do not plug or pull the plug with wet hand or wet cloth, so as to avoid electric shock.



PLUG OR PULL
THE PLUG

Before the washing / spin drying tub completely stops, do not touch the clothing being washed. Even if the tub is running at low speed, your hand may get wrapped up and injured. Special attention should be paid to children.



FORBIDDEN
TO
TOUCH

Do not change the original state of power cable. Any artificial damage to the power cable could cause electric shock, electric leakage or other malfunctions.



FORBIDDEN

Do not use damaged power cable, plug and loose plug socket, so as to avoid short circuit, electric shock, fire and other accidents.



FORBIDDEN

Do not use water to wash components of the machine, so as to avoid short circuit and electric shock.



FORBIDDEN
TO
WASH WITH WATER

Do not approach any fire source to a plastic component, which has the risk of starting a fire.



FORBIDDEN

Clean the dust on the plug and plug socket to avoid fire.



MANDATORY

Specifications 产品规格

Model 型号	ES-U106H	ES-U906H
Power supply 电源	240 V ~ 50 Hz	
Standard washing/ spin drying capacity 标准清洗/脱水容量	10.0 kg	9.0 kg
Standard water consumption 标准使用水量	129 L	127 L
Standard water level 标准水位	48 L	46 L
Washing / Spin Drying Rated Power Input 额定标准清洗/脱水功率	605 W / 360 W	600 W / 355 W
Washing type 洗涤方式	Swirl type 漩涡式	
Water pressure 进水压力	0.03 ~ 0.8 MPa	
Weight 产品重量	37 kg	
Dimensions (W×D×H (mm)) 外形尺寸 (长×宽×高)	580 × 625 × 1031	580 × 625 × 1011









Common non-fault phenomenon 常见的非故障现象

Phenomenon 现象	Check 检查
Not working Light cannot be on. 不能操作。 显示灯没有亮起	<ul style="list-style-type: none"> Is the plug plugged in firmly? 是否有紧紧地插好电源? Is the power supply interrupted or does the main switch in your house trip off? 电源是否收到干扰或是家里的总电闸关闭?
There's abnormal sound. 发出不寻常的声音	<ul style="list-style-type: none"> Does the washing machine incline or is it unstable? 洗衣机是否倾斜或是不平稳? Does the clothing deviate to one side during spin drying? 在脱水时衣物是否偏向一边? Is there a hair clip or other foreign metal objects mixed in the clothing? 是否有发夹或其他金属物品混杂在衣物内?
No water inlet. 没有水源流入	<ul style="list-style-type: none"> There's no water supply if the top cover is open. Please close the top cover properly. 如果盖板没有被关上是不会有水源流入。请将盖板仔细地关上。
Tap leaks. 水龙头的水泄漏	<ul style="list-style-type: none"> Are the screws or the installation position of the water nozzle connection loose? 是否有螺丝或是安装出水口的接口位置松开了? Does the water nozzle connection incline or shake? 出水口的接口时候倾斜或是不稳固?

Inspection of a washing machine that have been used for many years.
检查已经使用多年的洗衣机

 <p>Check 检查</p>	<p>Are there situations like these? 是否有这样的现象</p> <ul style="list-style-type: none"> Doesn't operate sometimes. 有时不会启动。 "CHILD LOCK" doesn't work during operation. 操作程序进行时童锁不能启动。 Water leakage (water hose, spinning tub, tap connection). 水溢满(水喉, 旋转桶, 水龙头接口)。 There is burning smell. 有烧焦的味道。 There is an abnormal sound or vibration during operation. 在操作程序进行中有不寻常的震动和声响。 Your hand feels numb while touching the machine. 当您碰洗衣机时手会麻痺。 Power cable or plug is unusually hot. 电线和电插头非常发热 	<p>Stop using the machine 停止使用此洗衣机</p>	<p>To avoid a fault y or an accident, please pull out the plug from the plug socket. Be sure to entrust the maintenance department to check it, and consult the maintenance department for check and repair fees. 为了避免故障和意外的发生, 请将插头从电插座拔掉。请保证委托维修部门进行检查和咨询他们有关检查和维修的费用。</p>
--	--	--	--

安全注意事项

警告	
	<p>禁止孩童玩弄或张望洗涤/旋转烘干桶, 以避免形成受伤。</p> <p style="text-align: center;"> 禁止</p>
<p>禁止在洗涤/旋转烘干桶内放入含有汽油, 煤油等其他有害洗涤剂衣物。</p> <p style="text-align: center;"> 禁止 </p>	<p>在洗衣/旋转烘干桶完全停转之前, 禁止触碰清洗后的衣物。即使洗衣/烘干桶处于低速转动, 您的手有可能被衣物缠绕而导致受伤。请严加注意孩童的一举一动。</p> <p style="text-align: center;"> 禁止触碰</p>
<p>禁止使用AC220-240V, 50Hz以外的电源以避免造成本产品的故障, 损坏和火灾。</p> <p style="text-align: center;"> 禁止</p>	<p>禁止改变电线原有的状态。电源线所受到任何人为的损伤会造成触电、漏电或其他的机器故障。</p> <p style="text-align: center;"> 禁止</p>
<p>除了专业的修理人员, 请不要擅自将产品进行改造。在没有批准下, 请不要擅自分解和修理本机器, 以避免造成火灾, 触电, 受伤或机器故障。</p> <p style="text-align: center;"> 禁止分解</p>	<p>禁止使用受损的电线、插头及松动的插座, 以免引起短路、触电和火灾等事故。</p> <p style="text-align: center;"> 禁止</p>
<p>禁止将本产品放置在如浴室, 风雨所及的地点, 和其他高度潮湿的场所。否则将会有触电、火灾, 机器故障和变形的可能性。</p> <p style="text-align: center;"> 禁止在高度潮湿场所使用</p>	<p>禁止在清洁本机器各个部分时用水直接冲洗, 以免引起短路或触电事故。</p> <p style="text-align: center;"> 禁止用水冲洗</p>
<p>单独使用13A以上的插座。插座松动或与其它电器产品共用同一样的插座可能会因为发热而引起火灾。</p> <p style="text-align: center;"> 必要</p>	<p>禁止将火源靠近塑料部份或零件有引起火灾的危险。</p> <p style="text-align: center;"> 禁止</p>
<p>当清理机身时, 应先拔去电源插头。禁止使用湿手或湿布去插和拔电源插头, 以防触电。</p> <p style="text-align: center;"> 插上或拔去电源插头</p>	<p>请仔细将电线插头、插座上的灰尘用干布擦拭, 以免引起火灾。</p> <p style="text-align: center;"> 必要</p>

Safety precautions

WARNING

- Do not wash water resistant clothing. Do not wash sleeping bags, bath curtains, raincoats, rain ponchos, rain covers, ski jackets, ski pants, automobile covers and other water resistant clothing, so as to avoid abnormal vibration and other unexpected accidents.



FORBIDDEN CAUTION



During spin drying, the washing machine is rotating at high speed. Because water in water resistant clothing could not be discharged instantaneously, the machine will be out of balance, causing abnormal vibration and other unexpected accidents.

- Do not wash objects other than clothing to avoid abnormal vibration that causes damage to machine.



FORBIDDEN

- The temperature of water must not exceed 50°C, so as to avoid accidents of electric leakage and electric shock due to distortion or damage of plastic.



FORBIDDEN

- While pulling out or plugging the plug, do not touch the metal part of the plug, so as to avoid electric shock or short circuit.



MANDATORY

- After using the washing machine, please pull out the plug, so as to avoid electric leakage, electric shock or fire due to loose connection of plug.



PLUG OR PULL OUT THE PLUG

- Before using, check carefully if the connection of water inlet hose or drain hose is reliable, so as to avoid water leakage.



MANDATORY

- When the machine is running, do not touch the bottom with hand or foot, where there's a rotating mechanism, so as to avoid getting hurt.



FORBIDDEN TO TOUCH

- Before using, check the bottom of the product, make sure there is no packaging material such as a plastic holder attaching on visual parts. And then install the bottom cover.



MANDATORY

- Do not put heavy objects on the machine, so as to avoid distortion and damage.



FORBIDDEN

- After using, please turn off the tap to avoid water leakage.



MANDATORY

- The base opening must not be obstructed by carpeting when the washing machine is installed on a carpeted floor.



MANDATORY

CAUTION

- To avoid danger, if the soft power cable is damage, it must be replaced by the manufacture or its maintenance department or similar dedicated personnel.
- If powder detergent or liquid detergent adheres to a plastic component such as the top cover, wipe it away immediately, otherwise it may damage the plastic component.
- Each time washing is finished, clean lint filter box. Otherwise it may not have effect to trap lint.

Common non-fault phenomenon 常见的非故障现象

Phenomenon 现象	Not a fault 非故障现象	
Water inlet 进水管系统 A sound in water hose and water inlet valve. 进水管和进水阀门发出声音	Because the pressure of tap water is relatively high. Please adjust tap connection. 这是因为水龙头的水压比较高。请调整水龙头的接口。	
Washing 清洗 When washing or rinsing is finished, the pulsator will rotate slightly. 当清洗或漂洗完毕后, 波轮会稍微的转动	To avoid the offset of clothing to reduce vibration during spin drying. 减少脱水过程中所产生的震动, 以避免衣物的偏离。	
Rinsing 和漂洗 During the washing process, the pulsator rotates discontinuously. 当进行清洗时, 波轮会持续地转动。	In the soaking and washing in soak course, the pulsator rotates once every 8 seconds, so that the detergent can permeate into the clothing sufficiently. 在浸泡的操作程序中的浸泡和清洗时, 波轮在每8秒钟会转动一次, 这样就可以让清洁剂更有效地渗透衣物内。	
Spinning 脱水 When spinning starts, low-speed rotation will happen for a while. (Do not rotate at high speed immediately.) 当脱水开始时, 低速的转动偶尔会发生 (没有立刻高速地转动)	This action is done to adjust the balance and to dry clothing sufficiently. 这个程序是为了调整平衡以及有效晾干衣物的水分。	
	When spinning starts, the machine gives off sounds like "PatsaPatsa". 当脱水开始时, 洗衣机发出 PatsaPatsa 的声响。	During spin drying, water hits the tub side, which is not abnormal. 在脱水时, 水会碰到洗涤桶旁, 这不是个非正常的现象。
	During spinning, the program inlets water and enters rinsing. (Spin light Indicator blinks quickly.) 在脱水时, 操作程式让水流入并进入漂洗程式。(漂洗显示灯快速地闪烁)	During the rotation in spin drying, the offset of clothing is detected and corrected automatically. (If the offset phenomenon cannot be changed by auto-correction, the operation will stop immediately.) 在脱水的转动过程中, 感应到偏离的衣物然后做自动的调整。(如果偏离的现象不能透过自动调整进行改变, 其操作程式会立刻停止。)
The clothing has been spin dried but not wringed dry. 清洗的衣物只有被甩干, 并没有被拧干。	The spin drying ratio of an automatic washing machine is a little lower than that of a twin tub washing machine. In case the spin drying of large clothing such as towels, blankets etc. is uneven, please spin drying it again. 自动洗衣机的脱水比例与双桶的洗衣机相比较低。倘若脱水后的大型衣物如毛巾, 毛毯等并不均匀, 请再次进行脱水程式。	
Operating parts heat up. 操作零件逐渐升温	It's caused by the heat radiation of electrical components. 这是因为电子产品散热的缘故而形成的。	
Indoor lighting darkens in an instant. 室内的灯光在顷刻变暗了	The voltage of plug loop in your house drops in an instant when the motor starts up. (Please use an exclusive plug loop.) 这是因为发动机启动时, 家里的电流插环瞬间下降。	
There's a sound of water when tub body is rotated. 在洗涤桶转动时听到水声	To keep balance during spinning, there's liquid in the balance ring. 为了让旋转时保持平衡, 在平衡环里装有液体。	
Others 其他 There's a stray noise on the radio or television, and the image is unclear. 收音机和电视机传出模糊的杂音, 电视画面也变得模糊。	Keep away from radio and television as far as possible. Please note that it will stick on where it is left. Using liquid detergent or injecting water and rinsing twice can prevent this phenomenon. 请将电视机和收音机放置在远离洗衣机的地方。	
After washing is finished, there are white lines around the washing / spin drying tub. 当清洗完毕后, 有一些白色的线条在洗涤/脱水桶内。	The white powdery material is the result of the combination of ingredients in detergent and ingredients in water (Wipe away with twisted cloth.) Please note that it will stick on where it is left. Using liquid detergent or injecting water and rinsing twice can prevent this phenomenon. 这些白色的物体是清洁剂和水混合起来而成的。(请用干净的抹布抹掉)请留意这些物体会遗留它在粘着的位置。用液体状的清洁剂或喷射水然后漂洗两次可以避免这种现象。	

常见的非故障现象(当出现您的洗衣机出现非正常的现象时, 请参考此部分)

非正常图象显示

注意 : 当出现非正常的图像显示时, 洗衣机会发出“哔”的提示音。倘若10分钟后没有任何的指示, 它将会自动关上。因为发生以下的状况并非是因机器的故障, 请在交由专业人士进行维修之前先做详细的检查。倘若问题得不到解决。请咨询产品保养部门。请确保不要在没有批准下擅自拆除或进行修理。

危险显示	可能出现的非故障问题	解决方案	问题原因	问题原因目录
E1	<ul style="list-style-type: none"> 水龙头的水流非常慢。 水龙头关上了 进水管的过滤网阻塞了。 	<ul style="list-style-type: none"> 增加水量, 按下开启/暂停按钮。 将水龙头打开, 按下开启/暂停按钮。 清理过滤网, 按下开启/暂停按钮。 	① ② ③ ④ ⑤ ⑥	①. 从软管中取得的水源触及不到水位感应器。
E2	<ul style="list-style-type: none"> 在预约模式开始时盖板还是开着。 盖板在脱水时没有被关上。 	<ul style="list-style-type: none"> 将盖板关上。 	② ④ ⑤ ⑥	②. 电流故障 ③. 进水阀门故障 ④. 电线没有被连接上
E3	<ul style="list-style-type: none"> 排水的位置非常高。 排水处的一端被阻塞了。 排水管被折着/打结/缠在一起。 	<ul style="list-style-type: none"> 调整排水软管, 然后按下开启/暂停按钮。 清理排水软管, 然后按下开启/暂停按钮。 	② ④ ⑥ ⑧ ⑨ ⑩	⑤. 接口连接失误 ⑥. 水位感应器故障 ⑦. 安全开关故障
E4	<ul style="list-style-type: none"> 洗衣机倾斜或不稳固。 桶内衣服位置偏离了。 	<ul style="list-style-type: none"> 利用脚去调整洗衣机并将它放置在平稳水平线上。 将衣物均匀地摆放。 	④ ⑤ ⑦	⑧. 排水阀门故障 ⑨. 排水阀门发动机故障
C2	<ul style="list-style-type: none"> 水位的感应器显示非正常的水平。 	<ul style="list-style-type: none"> 将插头从插座拔掉, 然后委托维修部门进行检查。 	① ⑥	⑩. 排水阀门发动机链接失败。
U9	<ul style="list-style-type: none"> 在童锁的程式中盖板被打开。 	<ul style="list-style-type: none"> 将电源关上然后从上下取下。 <p>注意 童锁不会被解除直到您手动设置为止。</p>	—	

安全注意事项



警告

- 禁止洗涤经防水处理的衣物。不要洗涤睡袋、浴帘、雨衣、雨布、雨罩、滑雪衫、滑雪裤、车罩等防水性衣物, 以免引起异常振动和其它意外事故。



禁止



注意

在旋转烘干时, 洗衣机在高速的状况下运转, 由于防水性衣物中的水无法在一瞬间排出, 洗衣机将失去平衡, 产生异常的振动和其它意外事故。



禁止放入防水性衣物

- 禁止洗涤衣物以外的物件以避免造成异常振动和造成机器的受损。



禁止

- 当洗衣机正在运行中, 禁止用手或脚触碰设有旋转功能的底部, 以避免造成伤害。



禁止触碰

- 确保水温在洗涤时不要超过50°C, 以免因塑料变形、损坏而导致漏电、触电事故。



禁止

- 在使用之前, 请先检查产品底部, 确认没有任何的包装材料如一个塑料支架, 然后再安装底板。



必要

- 当插入或拔出插头时, 避免手触及插头的金属部位, 以防发生触电或短路事故。



必要

- 禁止在机器上放置重物, 以避免造成变形和损坏。



禁止

- 当使用洗衣机完毕后, 请将电源插头拔掉以防止因插头松动所造成的漏电、触电或火灾等事故。



必要

- 使用完毕后, 请将水龙头关上以防止滴水。



必要

- 在使用前请认真检查进水管、排水管连接是否稳固以防止漏水。



必要

- 若将洗衣机置于地毯之上, 请确保底盖的开合不受影响。



必要

注意

- 为了避免事故的发生, 当发现电源软线有损坏, 请交由制造公司或其公司维修部或是相似的专业人员进行更换。
- 如粉末洗涤剂或液体洗涤剂粘附在塑料零件如顶盖时, 请马上将其擦拭干净, 否则将会损坏其塑料零件。
- 每一次的清洗衣物过后, 请将棉线过滤盒清洗干净, 以保证过滤效果。

Name of each component 各个部分零件名称

Machine body 洗衣机机体

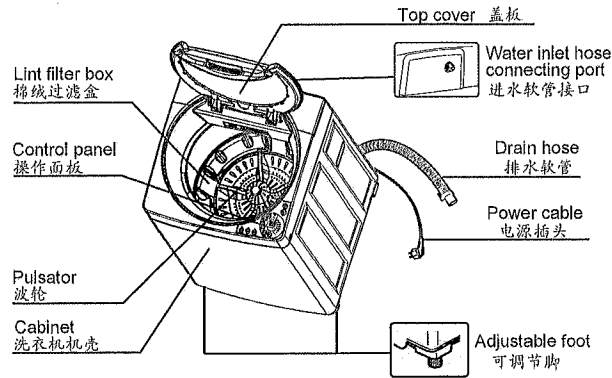

List of accessories 附件清单

Name 名称	Quantity 数量
Water inlet hose assembly 进水管组件	1 set 1套
Drain hose 排水软管	1
Screw 螺丝	1
Bottom cover 底盖	1
Operation manual 说明书	1
Installation manual 安装说明书	1
Warranty card 保修卡	1

Common non-fault phenomenon (Please refer to this section if there is an abnormality happens.)

Abnormal display

Caution : It generates a beep when washing machine indicates abnormal display. If not connected in 10 min, it turns off automatically.
Because the phenomenon may not be a fault, please check it again before sending the machine for repair. In the case of failure, please consult the maintenance department. Be sure not to disassemble and repair the machine without permission.

Present-ation	Possible non-fault cause	Coping process	Failure cause	List of failure cause
E1	<ul style="list-style-type: none"> Low flow at the faucet. The faucet is closed. Water inlet filter net is blocked. 	<ul style="list-style-type: none"> Increase water supply, press START / PAUSE key. Turn the faucet on, press START/PAUSE key. Clean filter net, press START/PAUSE key. 	① ② ③ ④ ⑤ ⑥	① Get water in tube of water level sensor ② Circuit failure
E2	<ul style="list-style-type: none"> Top cover is opened as the reservation course starts. Top cover is not closed during spin drying. 	<ul style="list-style-type: none"> Close top cover. 	② ④ ⑤ ⑥	③ Failure of water inlet valve ④ Wiring disconnection
E3	<ul style="list-style-type: none"> The drain position is relatively high. The end of drain hose is blocked. Drain hose is folded/crumpled/tied. 	<ul style="list-style-type: none"> Adjust drain hose properly, press START /PAUSE key. Clean drain hose, press START/PAUSE key. 	② ④ ⑥ ⑧ ⑨ ⑩	⑤ Connector contact failure ⑥ Failure of water level sensor ⑦ Failure of safety switch
E4	<ul style="list-style-type: none"> Washing machine inclines or shaky. The clothing is lopsided. 	<ul style="list-style-type: none"> Place washing machine place the horizontally by adjusting the foot. Distribute the clothing evenly. 	④ ⑤ ⑦	⑧ Failure of drain valve ⑨ Failure of drain valve motor
C2	<ul style="list-style-type: none"> Water level sensor shows an abnormal level. 	<ul style="list-style-type: none"> Pull out the plug from the plug seat, and entrust the maintenance department. 	① ⑥	⑩ Connect failure on drain valve motor
U9	<ul style="list-style-type: none"> Top cover opened in the situation of CHILD LOCK. 	<ul style="list-style-type: none"> Turn off the power off, and take it from the top. <p>Caution CHILD LOCK is not released, unless you reset it manually.</p>	—	

Maintenance 产品保养

TUB CLEAN 清洗洗涤桶

In the case of cleaning the washing / spin drying tub
在清洗洗涤/脱水桶的状况下

Caution 注意

- Do not put the clothing in the tub in this course.
在这个操作模式中不要置放任何的衣物。

1



Press Power ON/OFF key
with the top cover closed.

当盖板被关上的时候，按下电源开关按钮。

2



Press COURSE key,
and select TUB CLEAN course.

按下操作模式的按钮，然后选择清洗洗涤桶的操作程式。



Press WASH key, and select the washing time.
Press WATER LEVEL key, and select the water
level as necessary.

按下清洗按钮，然后选择清洗时间。
按下水位按钮，然后选择所需的水位。

3



Press START/PAUSE key.

按下开启/暂停按钮。

The washing machine starts to supply water,
and displays remaining operation time.

这时洗衣机将会开始提供水源，然后显示出剩余的操作时间。

The machine generates a beep when it finishes supplying water.
在完成水源提供时，洗衣机将会发出“哔”的提示声。

4



Press START/PAUSE key,
and the washing machine pauses.

按下开启/暂停按钮，然后洗衣机将会暂停操作。

Put the washing machine cleaner for
washing the tub.

倒入洗衣机清洁剂为洗涤桶进行清理。



5



Close the top cover and press START/PAUSE key
to restart.

将盖板关上，然后按下开启/暂停按钮重新启动操作程式。

Key points of washing 洗涤重点

Pay more attention to the following situations 请密切留意以下的情况

- Before washing, please remove sludge and sand on clothing first.
在洗涤之前，请先将衣物上的污泥和砂石清除掉。
- For very dirty parts of the clothes, you can smear some liquid
detergent on them and rub them in advance.
对于特别脏的衣物部分，您可以事先在衣物上涂上液体洗涤剂并将它搓揉。
- For clothing that are easy to pill, please turn it inside out first and then wash it.
对于容易起毛球的衣物，您可以将其翻到里面后才开始进行清洗。
- Large clothing and clothing that are easy to float should be put into
the washing tub first.
Please put large clothing and clothing that are easy to float (chemical fibers etc.)
at the bottom. This is beneficial to the good rotation of clothing.
至于大件和容易漂浮的衣服应该首先被放入洗涤桶内。
大件或容易漂浮的衣物（化纤等质地）应该被置放在底部。这有助于衣服的良好旋转。

To avoid damage to tub, pulsator...

为了避免将洗涤桶，波轮等造成损坏...

- Please take out coin, hair clip, curtain
hook and other metal.
请将硬币，发夹，窗帘挂钩等其他金属拆除。
- Wrap up buttons and zipper and put
them on the inner side.
将纽扣和拉链包扎并置于内侧。
- Put bra etc. in washing mesh bag.
将胸罩等放入洗涤网袋内。

To avoid damage to clothing, winding of clothing...

为了避免衣物受损的缠绕...

- Belts on apron and so on must be
knotted; zippers must be zipped.
将围裙等带子打结；务必将拉链拉上。
- Thin or easily damaged clothing must
be washed in washing mesh bag.
稀薄或容易受损的衣物应放置在洗涤网袋内
进行清洗。
- Metal decorations (zippers etc.) on the
clothing in washing mesh bag must be
checked.
将放置在洗涤网袋内缝上金属类装饰品的衣物
(如拉链等)进行检查和确认。

For better washing...

为了更好的洗涤...

- Please check the washing mark.
请检查洗涤标签。
- Wash clothing easy to fade separately.
将容易褪色的衣物分别进行清洗。
- For towels and other clothing easy to
produce lints, please wash them
separately or use washing mesh bag.
对于容易产生毛球的毛巾和其他衣物，请将
它们分开进行清洗或是使用洗涤网袋清洗。

To protect the environment

为了保护环境

- ...To avoid the waste of water, detergent
and electricity.
...避免浪费水源，洗涤剂和电源
- During washing, wash clothing together.
在进行清洗时，尽可能同时清洗衣物。
- Put in proper amount of detergent
according to the fouling situation.
根据衣物的污垢程度加入适量的洗涤剂。
- Reuse detergent liquid.
再循环使用洗涤剂。

While using a washing mesh bag, put in as little clothing as possible. Too much
clothing will decrease the performance during rinsing and spin drying or cause
the offset of clothing during spin drying.

在使用洗涤网袋时，尽可能放少量的衣物。过量的衣物将会在漂洗和脱水的过程
中减低其性能或是在脱水的过程造成衣物的偏置。

Instruction on control panel functions

Control panel / Display

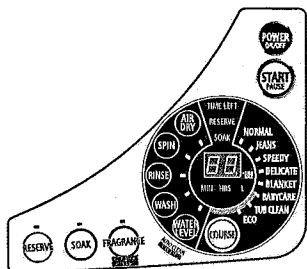

POWER ON/OFF	POWER : Plug the machine in and then press this key, the machine turns on. Press this key again, it turns off. Caution 1.If the machine is energized but not started, the power supply turns off automatically 5 min later. 2.If no key pressed after the START/PAUSE key is pressed during the operation, the power supply turns off automatically 10 min later.
START/PAUSE	START/PAUSE : Press this key after turning on, selected course is started. Press this key again, the running is paused. Press it once again, the running restarts.
COURSE	NORMAL : Wash daily clothing like relatively-dirty shirts or pants. JEANS : Wash heavy and very dirty clothing. SPEEDY : Wash speedy for not-so-dirty clothing. DELICATE : Wash clothing with the HAND WASH mark. BLANKET : Wash strong for blankets or heavy clothing. BABYCARE : Wash gently and rinse thoroughly for baby clothing. TUB CLEAN : Course for cleaning washing / spin drying tub. Select the washing time: 2 hrs, 6 hrs, 9 hrs. ECO : Water is saved by 1 time static rinse.
WASH	WASH : Select WASH as necessary. Select the washing time: [-](= 0 min), 1 min - 15 min.
RINSE	RINSE : Select RINSE as necessary. Select the rinsing time: [-](= 0 min), 1 time - 3 times.
SPIN	SPIN : Select SPIN as necessary. Select the spinning time: [-](= 0 min), 1 min - 9 min.
AIR DRY	AIR DRY : Course for reducing the time to dry. Spin-drying with high-speed takes air into the inner tub from the hole of top lid. AIR DRY course reduce the time to dry in the shade greatly. Select the time: [-](= 0 min), 30 min, 60 min, 90 min.
WATER LEVEL	WATER LEVEL : Select the appropriate water level depending on course or kinds of clothing. (Select from 8 steps regulation)

Maintenance 产品保养

It is possible to extend a life of washing machine with an appropriate maintenance. 适宜的产品保养有助于延长洗衣机的寿命

Water inlet hose connecting port 进水软管接口

For the prolonged use, the filter net is very easily blocked. Please clean it in the following way. 由于长期的使用, 过滤网非常容易被阻塞。因此请根据以下的方式清洗干净

1. Turn off the faucet. 将水龙头关上	2. Turn on the power and press WATER LEVEL key. 开启电源然后按下水位按钮	3. Confirm if top cover is closed. 开启电源然后按下水位按钮	4. Press START /PAUSE key. 按下开启/暂停按钮 Make sure the water in the hose has been drained. About 10 min later, turn off the power. 请确保软管内的水已经被排出。等待大约10分钟, 将洗衣机的电源关闭	5. Dismantle water inlet hose. 拆除进水软管 Caution 注意 Twist connecting part, not hose. 扭转接口而非进水软管	6. Clean the filter net. 清洗过滤网 Caution 注意 Remove the filter net and clean it. 拆除过滤网并进行清洗

Lint filter box 棉绒过滤盒 Clean it each time after washing 每次进行洗衣后将滤盒清理干净

1. Detach lint filter box from washing tub. 将棉绒过滤盒从洗涤桶拆除出来。	2. Clean lint filter box and the tub side. 清理毛绒过滤盒以及洗涤桶的边缘。	3. Attach lint filter box on washing tub to a downward direction. 以向下的方式将棉绒过滤盒重新安置在洗涤桶。



Washing / Spin Drying tub 清洗洗涤/脱水桶

- Each time after washing, please turn off the faucet and power. (If necessary, please dismantle water inlet hose.)
每一次洗涤完毕后, 请将水龙头和电源关上 (如果有必要, 请拆除进水软管)
- Please wipe the water in the tub away after washing as soon as possible.
洗涤完毕后, 请尽快将洗涤桶内的水擦干。
- Be sure to pull out the plug from the plug socket during maintenance.
在进行保养时, 请确保将电源插头从插座拔掉。
- Hanging power cord and drain hose is desirable.
应该将电线和水管挂起。
- Please open top cover for about 1 hour after wiping away the water and the persistent dirt in the tub cleanly with clean and soft cloth.
在抹去多余的水分和以干净柔软的抹布清洁洗涤桶内的灰尘后, 请将盖板开着大约一小时。
- Please do not use solvents such as alcohol, cleanser and so on, because they may cause damage to the surface of the tub.
请避免使用溶剂如酒精和清洁剂之类的用品在此产品上, 因为其功效或许会为洗涤桶的表面造成损坏。

Additional operating procedure

其他操作程式

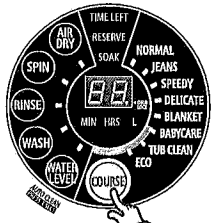
FRAGRANCE 芬芳

			
<p>1. Press POWER ON/OFF key. 按下电源开关按钮</p>	<p>2. Press COURSE key, and select the necessary course. 按下操作模式按钮, 然后选择所需的操作模式。</p>	<p>3. Press FRAGRANCE key, and the light turns on. 按下芬芳按钮, 然后显示灯会亮起。</p>	<p>4. Press START/PAUSE key.</p>

CHILD LOCK 童锁

	<p>While the power supply is "ON" status, hold down "FRAGRANCE" key for 3 seconds. After emitting a beep, "L" is displayed for 3 seconds, and then the machine is locked. (If you want to cancel, hold down this key for 3 seconds again) 当电源属于开启的状态, 持续按下“芬芳”按钮3秒钟。当洗衣机发出“哔”的显示音, “L”将会出现约3秒钟, 接着洗衣机即被上锁。 (倘若您取消其模式, 再次按下这个按钮长达3秒钟)</p>
---	--





CLEAN WASHING / SPIN DRYING TUB

清洗洗涤/脱水桶

	<p>While the power supply is "ON" status, hold down "WATER LEVEL" key for 3 seconds. After emitting a beep, "C" is displayed for 3 seconds, and then the machine starts to clean the washing / spin drying tub. (This course adds a cleaning process, at the end of spinning, and prevents secondary contamination on the tub) 当电源属于开启的状态, 持续按下“水位”按钮3秒钟。当洗衣机发出“哔”的显示音, “C”将会出现约3秒钟, 接着洗衣机将开始清洗洗涤/脱水桶。 (这个操作模式在脱水程式的最后增添了清洗功能, 以避免洗涤桶污染)</p>
---	--

Instruction on control panel functions

Control panel / Display

	<p>RESERVE : Reserve the time as desired. Select the time: 1 hr – 24 hrs. Reserved time indicates the time to finish the operation. It means, the operation finishes 1 hour later when 1 hr is selected. Set the time after selecting the necessary course.</p>
	<p>SOAK : This course can be added to every course except for TUB CLEAN course. When the SOAK course is selected the light is turned on. During soaking, the water in the tub is stirred intermittently. Select the soaking time: 5 min – 24 hrs.</p>
	<p>FRAGRANCE : This course enhances softener's efficacy. Adds the time to soak in the water containing softener at the beginning of final rinsing.</p>
<p>Additional function</p>	<p>CHILD LOCK : CHILD LOCK is set by holding down FRAGRANCE key for 3 sec. The error tone can be heard if top cover is opened after water supply start. If top cover has been opened for 30 sec in such condition, the water is automatically drained.</p> <p>  It is only possible to operate only POWER key and START/PAUSE key in this mode.</p> <p>AUTO CLEAN : AUTO CLEAN is set by holding down WATER LEVEL key for 3 sec. (Remove the dirt in the washing / spin drying tub and the back side of pulsator with clean water at the final spinning.)</p>

- The washing machine displays the water level at the beginning of operation.
- The washing machine displays the remaining operation time during the operation.
- The washing machine displays reserved time during the RESERVE course operation.
- The washing machine displays a presentation in the page 19, when an abnormality happens.

操作面板功能说明

操作面板/屏幕显示

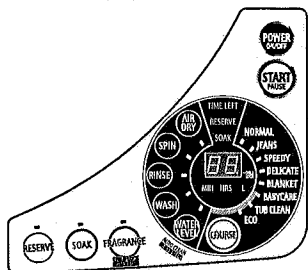

	<p>电源开关 : 将洗衣机插头插入电源然后按下这个开关, 洗衣机将会被启动。再次按下这个开关, 洗衣机的电源将会被切断。</p> <p>注意</p> <ol style="list-style-type: none"> 倘若洗衣机在通电的状况下却没有被启动, 电源将会在五分钟过后自动被切断。 倘若在清洗过程中按下开启/暂停的按钮却没有按下任何的操作按钮, 电源将会在十分钟过后自动被切断。
	<p>开始/暂停 : 在开启电源后按下此按钮, 然后所选择的操作程式将会开始。再次按下此按钮, 所有的操作程式将会暂停。再次按下此按钮, 操作程式将会再次启动。</p>
	<p>普通 : 清洗日常的衣物如肮脏的衣服和裤子。</p> <p>牛仔裤 : 清洗较厚和十分肮脏的衣物。</p> <p>快速 : 快速清洗轻微污渍的衣物。</p> <p>柔嫩 : 清洗拥有手洗标签的衣物。</p> <p>毛毯 : 清洗厚重的毛毯或衣物。</p> <p>婴儿 : 仔细和细腻地清洗婴儿的衣物。</p> <p>清洗洗涤桶 : 清洗洗涤/旋转烘干桶。选择清洗时间: 2, 6或9小时。</p> <p>环保 : 通过一次的静态漂洗节省水源。</p>
	<p>清洗 : 根据需要进行清洗。选择清洗时间: [-] (=0分钟), 1-15分钟</p> <p>漂洗 : 根据需要进行漂洗。选择清洗时间: [-] (=0分钟), 1-3次</p> <p>脱水 : 根据需要进行脱水。选择清洗时间: [-] (=0分钟), 1-9分钟</p>
	<p>风干 : 减少风干时间的操作模式。高速的旋转风干模式将空气重顶盖的洞口带入内置桶里。风干模式减少在遮荫下所需的脱水时间。选择时间: [-] (=0分钟), 30, 60, 90分钟</p>
	<p>水位 : 根据衣物的材质和选择的模式选择适合的水位。(从8项条纹做出选择)</p>

Additional operating procedure

其他操作程式

RESERVE 预约

1. Press **POWER ON/OFF** key. 按下电源开关按钮
2. Press **COURSE** key, and select the necessary course. 按下操作模式按钮, 然后选择所需的操作模式。
3. Press **RESERVE** key, and set the time as desired. Display represents reservation time: 1hr → 24hrs. 按下预约按钮, 然后设定所需的时间。图示显示预约时间。1小时—24小时
4. Press **START/PAUSE** key. 按下开始/暂停按钮

5. Start the reservation program. 开始预约的操作模式。
6. The time setting counts down to show the remaining time. 时间设定将倒数剩余的时间。
7. The machine generates a beep and turns off when it finishes the course. 洗衣机将会发出“哔”的提示声然后再操作模式完成后自动停止操作。

SOAK 浸泡

1. Press **POWER ON/OFF** key. 按下电源开关按钮
2. Press **SOAK** key, and set the soaking time as desired. Display represents soaking time (11 steps): 5min → 10min → 20min → 40min → 60min → 2hrs → 3hrs → 4hrs → 8hrs → 12hrs → 24hrs 按下浸泡按钮, 然后设定所需浸泡的时间。图示显示浸泡时间。(11个步骤) 5分钟→10分钟→20分钟→40分钟→60分钟 →2小时→3小时→4小时→8小时→12小时→24小时
3. Press **START/PAUSE** key. 按下开始/暂停按钮

4. The machine generates a beep and turns off when it finishes the course. 洗衣机将会发出“哔”的提示声然后再操作模式完成后自动停止操作。

Self-decided washing course

自选洗涤程序

Only spinning etc. 只选择漂洗或其他程式

Ex. Only rinsing and spinning
例子 只是漂洗和脱水



Put the clothes in the tub,
and press Power ON/OFF key.

将衣物放进洗涤桶内，然后按下电源开关按钮。

- Select the course as necessary.
选择所需的操作程式。



Select the necessary processes.
选择所需的操作程式

- Before starting of rinsing, please select [Water level].
在开始漂洗程式之前，请选择水位

In the cases below
若有以下的状况

Only spinning 只需脱水 →

Only draining 只需排水 →

(In case of only draining, please keep the top cover open.
The machine displays [E2] when it finishes draining.)

(在只需排水的状况下，请将盖板打开。当排水完毕后，洗衣机将会显示【E 2】的图像)

- Reuse of detergent liquid
(There is detergent liquid left in the tub)

循环使用洗涤剂
(将洗涤剂遗留在洗涤桶内)



3



Press START/PAUSE key.
按下开启/暂停按钮。

操作面板功能说明

操作面板/屏幕显示

	预约 ：预约所需的时间。选择时间：1-24小时。 所预约的时间代表着操作模式完成的时间。 这表示当选择1小时的模式时，所有的操作程式将在1小时时候结束。根据所需的操作模式后选择适当的时间。
	浸泡 ：这个操作程式可以加入在每一个操作程式除了清洗洗涤桶操作模式当选择浸泡模式时，显示灯会亮起。 浸泡模式进行时，洗涤桶内的水位将会间歇性地被搅拌。 选择时间：5分钟-24小时
	芳香 ：这个操作程式可以增强柔软剂的功效。 在最后漂洗开始前加入浸泡了柔软剂的水所需的时间。
附加模式	童锁 ：只要按下芳香按钮3秒钟将会启动孩童上锁的模式。 当水源开始输入但盖板却被打开时，错误显示音将会响起。 倘若盖板在这样的状况下打开超过30秒，水将会被自动排放。 在这个模式，只有重新按下电源开关和开启/暂停按钮才能重新开始操作。 自动清洗 ：只要按下水位按钮3秒钟将会启动自动清洗的模式。 (在最后的漂洗操作利用干净的水清洗洗涤桶的污渍和波轮的后方。)

- 洗衣机在操作开始之前显示水位。
- 洗衣机在操作过程中显示剩余的操作时间。
- 洗衣机在预留模式中显示预留的时间。
- 当面对非正常的状况，洗衣机将会显示出第20页的图像。

Things to know before washing

洗涤前须知事项

- Select the course depending on the type of clothing or degree of dirt on clothing.
根据衣物的材质和污渍的肮脏程度选择适合的操作模式。
- After pressing START/PAUSE key once, you cannot change the course. When you want to change the course, turn off the power and select the desired course again.
当按下开启/暂停按钮，您将无法转换操作模式。倘若您想转换操作模式，请将电源关上并重新选择您想要的操作模式。
- Blinking display indicates the step in operation, lighting display indicates the course selected.
闪烁的显示灯代表着模式的步骤，灯光显示所选择的操作模式。
- When motor get hot beyond a safe limit, it fail-safes on it and stops the operation. Do not use more than 3 continuous runs.
当发动机超过了一定的安全水平持续发热，其洗衣机正在处于故障保险并立即停止操作。禁止超过3次连续使用。

Caution 注意

1. When it fail-safes on the motor, it stops operation. After cooling down, it can be used normally.
洗衣机正在处于故障保险时，请立即停止操作。让洗衣机冷却下来后，它将能重新正常操作。

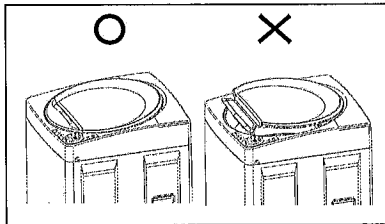

2. When top cover is not closed firmly, the machine cannot run. Please put cover handle down with care.
当盖板没有紧实地被关上，洗衣机将不能操作。请细心地将顶盖关上。

Instruction on washing courses

洗涤程序指南

Automatic sensing function 自动感应功能

The washing machine selects the way to wash with sensing the weight of clothing. The way includes water level, current of water and operation time. When you select water level or change the specific course manually, the automatic sensing function does not work. In the case of operating the automatic sensing function, there should be no water or extremely little water in the tub.

此洗衣机通过感应清洗衣物的重量选择清洗的操作模式。这包括了水位，水流，和操作程式时间。当您手动选择水位或改变特定的操作程式，这个自动感应功能将不会启动。在使用自动感应的功能时，桶内应该不含有任何或是少量的水。



1. Press POWER ON/OFF key.
按下电源开关按钮

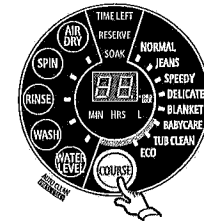

2. Press COURSE key, and select NORMAL course.
按下操作模式按钮，然后选择普通操作模式



3. Press START/PAUSE key.
按下开始/暂停按钮

4. The machine generates a beep and turns off when it finishes the course.
洗衣机将会发出“哔”的提示声然后再操作模式完成后自动停止操作。

Caution 注意

If you select water level as desired in the normal course, the automatic sensing function does not work.
如果您在普操作程式中选择您先要的水位，自动感应模式将不会启动。

AIR DRY 风干



1. Press POWER ON/OFF key.
按下电源开关按钮



2. Press AIR DRY key, and the light turns on. Display represents drying time: 30min → 60min → 90min → 0
选择风干操作模式，然后显示灯亮起。图象显示风干时间。30分钟-60分钟-90分钟-0



3. Press START/PAUSE key.
按下开始/暂停按钮

4. The machine generates a beep and turns off when it finishes the course.
洗衣机将会发出“哔”的提示声然后再操作模式完成后自动停止操作。