

SHARP

OPERATION MANUAL

FULLY AUTOMATIC WASHING MACHINE

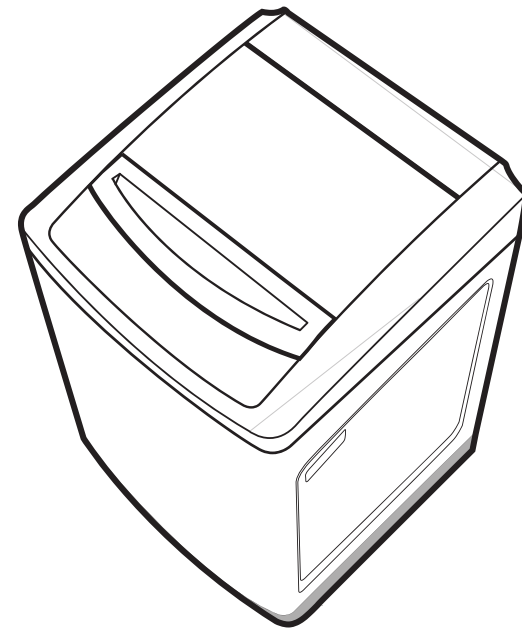

MODEL:ESV1415
ESV1615



Before operating this washing machine, please read these instructions carefully and completely.

TABLE OF CONTENTS







SAFETY PRECAUTIONS	2~4
CARE AND MAINTENANCE	4
ACCESSORIES	5
COMPONENT PARTS	5
HOW TO INSTALL	6~8
CONTROL PANEL FUNCTIONS	9~10
STANDARD USE	11
HOW TO SET CUSTOMIZED PROGRAM	11~12
HOW TO USE DELICATE WASH	13
ADDITIONAL FUNCTIONS	13~15
PRESET	13
MEMORY	14
INTELLIGENT WASH	14
WATER LEVEL CHANGE	14
CHILD PROOF	14
DELETE THE END BUZZER	14
DRAINING	15
TUB CLEAN	15
AIR BUBBLE+	15
TROUBLESHOOTING GUIDE	16
NON-FAULT PHENOMENON	17
SPECIFICATIONS	18

SAFETY PRECAUTIONS

- Please read these instructions carefully for proper operation before using your machine.
- The precautions stated here are classified as "Warning" and "Attention" according to the damage and the emergency caused by misoperation, and are described respectively in line with the marks below.

	Warning	With no respect to mark, the misoperation may cause death or GBH.
	Attention	With no respect to mark, the misoperation may cause body harm or object damage.

		
This mark indicates the content of warning or attention.	This mark indicates the prohibited action.	This mark indicates the compulsory action to be carried out.

 Warning	
<ul style="list-style-type: none"> • Dismantle, repair or alterations should only be carried out by professional technicians. Avoid electric shock, fire, and body injury due to improper activity. 	<ul style="list-style-type: none"> • This washing machine is equipped with the electricity wire with bielectrode grounding socket. The creepage protector shall be used if possible. To prevent electricity leak which may cause injuries. 
<ul style="list-style-type: none"> • Electricity supply must be unplugged with dry hands. Otherwise, this may cause electric shock. 	<ul style="list-style-type: none"> • Do not put water in direct contact with the unit during maintenance and repair. This may cause short circuit or electric shock. 
<ul style="list-style-type: none"> • Damaged or loosen wire or plug should not be used. Otherwise electric shock, short circuit or fire may take place. • Do not damage wire. DO not damage or alter the wire forcibly bend, pull twist or handle the wire. Beside, please do not put weight on or trap the wire. Damage of wire may case electric shock or fire. 	<ul style="list-style-type: none"> • Do not put gasoline, benzine, alcohol, thinner of fabrics with these stains into or near to the washing machine. To prevent fire or explosion which may cause injuries. 

SAFETY PRECAUTIONS

⚠ Warning

- Keep child away from the washing spin tub and do not place box or shelves next to the washing machine. children may fall into the tub resulting in injuries.

This appliance is not intended for use by persons (including children) with reduced physical, sensory or mental capabilities, or lack of experience and knowledge, unless they have been given supervision or instruction concerning use of the appliance by a person responsible for their safety.



Prohibited

- Do not put your hand into the tub until it has stopped completely.

Even when the spinning of the tub is slow, there is still a danger of being caught in the motion, resulting injuries. Particular attention should be paid when children are around.



Prohibited

- Do not put your hands into the spin tub during the washing and rinsing process.

Even when the spinning is slow, hands may be trapped by clothes. If necessarily, please press pause button, and put your hands into the basket after it has stopped completely.



Prohibited



- Please use the single socket with special voltage and current matched with plug marked specification.

The share of the same socket with other electric appliances may cause fire due to excessive.



Clear

- Thoroughly wipe the power plug when dirt is adhering to the prong or around the base of the prong.

Failure to do so may cause a fire.

- Washing machine should not be installed in humid place or in places exposed to wind and rain.

Otherwise, electricity leak causing electric shock or fire may occur.

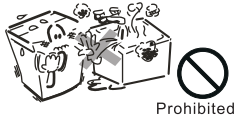

Prohibited

- This washing machine is strictly prohibited to get close to the locations with candle, mosquito-repellent incense, dog-end or other kinds of open flame.

To avoid injuries caused by the lock damage.



Prohibited

⚠ Attention

- Do not pull the wire from the socket when unplugging the unit.

To avoid electric shock or fire caused by short circuit may result.



Prohibited



- Please unplug the unit when not using the unit for a long period of time.

Electric shock or leakage may occur due to deformation of plastic parts of the unit.



- Electricity supply must be unplugged with dry hands during maintenance and repair.

Otherwise, electric leakage causing injuries may occur.

If the power cord or supply cord is damaged, the manufacturer or its service agent or similarly qualified person must replace it in order to avoid a hazard.

- Do not use hot water above 50 °C.

Hot water may cause plastic parts to deform and damage the unit.



Prohibited

SAFETY PRECAUTIONS

⚠ Attention

- Do not wash, rinse and spin the water proof fabric or cloth.

Sleeping bag, raincoat, cover of skiing, utilities, bicycles, cars and motors. Otherwise may lead to injury by abnormal vibration during spinning or damage the washing machine, wall, floor and clothes.

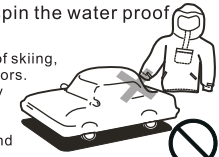

Prohibited

- Do not stand on or put weight on the top of the unit.

Otherwise, deformation and damage may result causing injuries.



Prohibited

- Keep hands and feet away from the bottom of washing machine when it is operating.

Ports in motion beneath the unit may cause injuries.

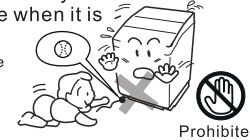

Prohibited



Water leakage

- Check water supply hose connection by turning on the water before washing. To prevent damages caused by possible water leakage due to loosen screw.

- The new hose-sets supplied with the appliance are to be used and that old hose-sets should not be reused.

- Do not block the ventilation openings on the bottom of washer by carpeting when the washer is installed on a carpeted floor.



Water leakage

- Water supply hose should be tightly screwed to the unit.

Failure to do so may result in water leakage. Used for a long period of time, the unit may result in water leakage caused by loosen union nut. So please check it in time and screw tightly again.

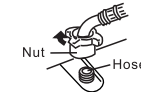

- Please turn off the water tap when not using the unit.

To prevent damages caused by water leakage.



CARE AND MAINTENANCE

Cleaning washing machine

Use soft clothing to wipe off the water or dirt on the surface of the washer.

- Do not spray water directly to the washer body.
- Detergent, propellant and other chemicals are not allowed to use to avoid the damages on the surface.



Cleaning water inlet valve

(It is suggested to do cleaning once every 6 months)

After long time use, The water inlet mesh bag may be blocked with crud, please load off the water inlet hose, take out the water inlet mesh bag from the water inlet valve, clean the mesh bag, then assemble the mesh bag in the valve and load the water inlet hose.



Cleaning Universal connector

(It is suggested to do cleaning once every 6 months)

1. Pull the water inlet hose out.
2. Turn off the revolver according to the figure shown.
3. Load off the Universal connector Joint filter and clean the crud with a toothbrush.
4. Install the clean Universal connector filter to revolver and water inlet hose.



Filter





Cleaning lint filter

(It is suggested to do cleaning once every week)

1. Take out the lint filter.
2. Pull out the scraps and wash the lint filter in the water.
3. Install the Filter (aim the frame claw to the groove below).

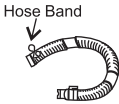

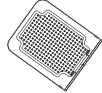
ACCESSORIES

Instruction manual	Drain Hose	Water Supply Hose	Universal Connector	Bottom Cover	Screw	Drain hose hooks
						

COMPONENT PARTS

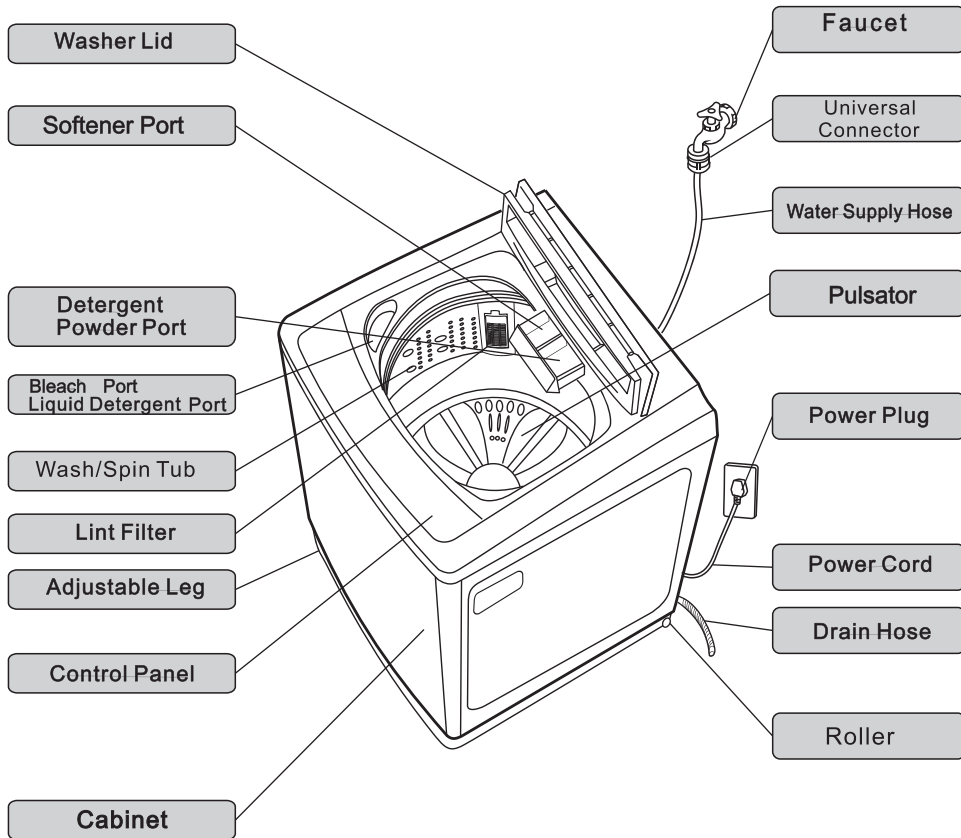

HOW TO INSTALL

Installing the Bottom Cover

1. Unplug the power cord of the washer. shield panels and parts bag of screws.
2. Gently lay down the backside of washer on a soft mat or cushion. (Be careful not to dent the cabinet)
3. Insert the attached Bottom Cover into the hooks of Leg by straightly pushing until it reaches into the front hooks.
4. Fasten the Bottom Cover with a screw.
5. Gently set the washer upright.

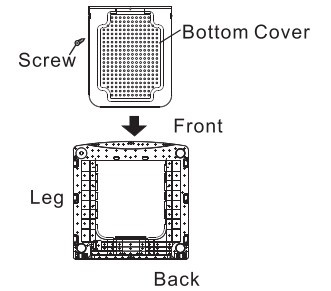

Location of Washer

1. Avoid place where the machine is exposed to direct sunlight.
2. Install the washer on a stable and level surface.



3. Adjust the Adjustable Leg of washer if necessary to make the washer level as shown in the figure.

- The maximum permissible inclination of the supporting surface is 2°.

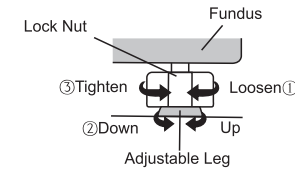

Attaching The Universal Connector To a Faucet

Faucet: Type A :is the most suitable

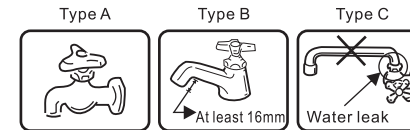

- Type B : The length of the mouth of the faucet needs to be at least 16mm. If it is less than 16mm, the Universal connector can not be installed.
- Type C : It may cause water leaking.

CAUTIONS:

- Do not use hote water above 50°C .
- If your faucet is not suitable, please consult your dealer.

HOW TO INSTALL

How to Attach the Universal connector

1. Separate the Universal connector and the Water Supply Hose by holding the Universal connector in one hand and pressing the Lock Lever in another hand.
2. If the outer diameter of the tap is larger than the calibre of the Joint Ring, loosen the four screws and remove the Joint Ring from the Universal connector.
3. Loosen the four screws and slide the top of the Universal connector onto the tap while making the two screws against the wall contact the tap fully first.
4. Securely tighten the four screws provided with the Universal connector by using a screwdriver to secure the top of the joint to the tap.
5. Remove the CAUTION label from the Universal connector.

Connecting the Water Supply Hose to the Universal connector

1. Turn the nut clockwise while holding the hose.
2. Turn the nut counterclockwise after turning the tap off when you want to detach the water supply hose.
3. Make sure inlet hose is properly connected.
 - While pushing the sleeve on the female coupler of the joint down with your fingers, connect the female coupler to the male coupler.
 - Release the sleeve, then push the Water Supply Hose up into the Universal connector until it clicks into place.
 - Pull the Water Supply Hose down to make sure that it is securely attached.

How to detach the Water Supply Hose

1. Turn the tap off.
2. Press POWER ON/OFF button to turn on power, then press the START/PAUSE button.
3. Press the POWER ON/OFF button to turn power off 15 seconds later.
4. While pushing the lock lever and the sleeve on the female of the joint down with your fingers, detach the female coupler from the male coupler.
5. Turn the water inlet hose anti-clockwise, till it gets detached.

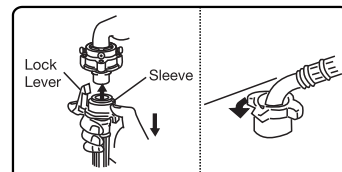

Installing the Drain Hose

Place the clip part of the Hose Band sideways to prevent it from touching the frame which may cause a vibration noise.

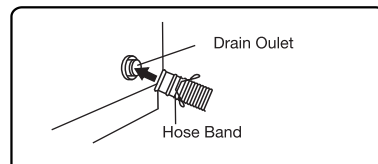

HOW TO INSTALL

Extension of the Drain Hose

When extending the external Drain Hose, please follow the below figure for the length and height.

Extension Hose	Height	Length
No straight	Max. 15cm	Max. 1m
Straight	—	Max. 3m

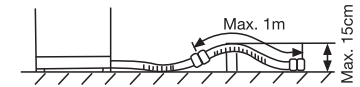

How to install drain hose hooks

1. Before installing the drain hose hanger, make good drainage hose direction adjusted.
2. Drain hose hooks attached to one side of the face where the washing machine drain hose rack or cabinet suitable location.
3. When the washing machine is not used, please hang up the drain hose.

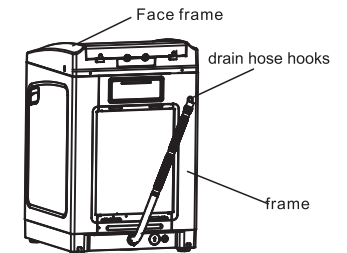

TO USE ROLLER

- Roller will help you to move the washing machine more easily. To move the washing machine, hold the rear part and tilt the machine, push or pull forward by holding your hand on both sides of the machine.
- Do not use roller on uneven floor to avoid roller damage.
- Do not tilt the machine with strong force to avoid personal injury.

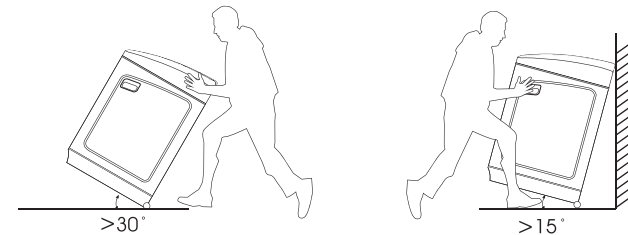

CONTROL PANEL FUNCTIONS

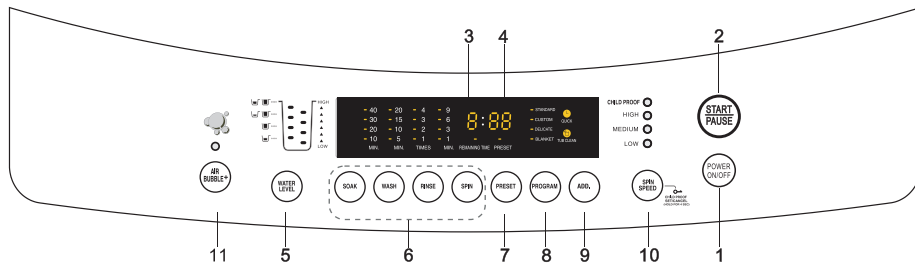

1. "POWER ON/OFF"

Turn power on by pressing this button, press again to turn off. After turn on, power will off automatically if idle for 10 minutes. After washing course finish, power will turn off in 5 sec.

2. "START/PAUSE"

Turn power on, press this button to start washing. Press this button again machine will stop running. To resume, press again this button.

3. DISPLAY SCREEN

After select program, screen will display wash time, rinse time, and spin time.

4. LED DISPLAY

-After machine start running, LED will show remaining wash time.

Eg. Left time is 20min. ----- 20

-LED will display how many hours remaining for preset mode to complete.

Eg. Left time is 2 hour. ----- 2

-LED will display error code when error occur.

Eg. No water in E1. ----- E1

Note: For display E901 and other 4 digits error code, the digital display area will flash alternately display the error code.

5. WATER LEVEL

Press this button to choose appropriate water level. Both WASH and RINSE course can choose different water level separately. First and second lowest water level are not available for DELICATE course.

6. "PROCESS" buttons

-You can set soak time, wash time, rinse times and spin time by these buttons.

-Before start, press "SOAK" button, you can set 0-40 min of soak time. (This cannot function for "DELICATE" and "TUB CLEAN" programs.)

-The indicator of each process flash while working.

CONTROL PANEL FUNCTIONS

7. "PRESET"

-To set the finishing time of preset mode.

-Press this button, the "PRESET" indicator will flash, and LED will display the preset hours.

-For "DELICATE", "QUICK" and "TUB CLEAN" programs, the preset does not function.

8. "PROGRAM"

-There are 4 auto programs "STANDARD", "CUSTOM", "DELICATE", "BLANKET".

-If the "STANDARD", "CUSTOM" and "BLANKET" program is chosen, the washer will automatically judge proper water level and flowrate.

9. "ADDITIONAL FUNCTION"

- Press this button to choose "TUB CLEAN" program or "QUICK" program.

-If the "QUICK" program is chosen, the washer will automatically judge appropriate water level and flowrate.

10. "SPIN SPEED"

-Press this button, to set spinning speed. When using the individual programs, will be affected by the choice of spin speed limit. This button can also be used to set "CHILD PROOF" function. See details in "CHILD PROOF" function.

11. "AIR BUBBLE+"

Press this button before start to activate AIR BUBBLE+ function.







(After machine starts, the "AIR BUBBLE+" function is automatically started)

STANDARD USE

1. PREPARATION

- Install the drain hose to machine.
- Connect the inlet hose to the faucet and turn on the faucet. Before turning on the faucet, please make sure the connection is firm. If the inlet hose is not firmly connected to the faucet, there may be water leakage.
- Connect plug to socket.
- Put clothing into washer.
- 2. Press "POWER ON/OFF" button
- 3. Press "START/PAUSE" button
- The sensor will automatically judge clothing weight for programs "STANDARD", "CUSTOM", "BLANKET" and "QUICK".
- The washer will automatically choose water flow and water level.
- 4. Please use proper amount of detergent according to table below.
- 5. Close the washer lid.

If the washer lid is not closed, the washer will stop before start spinning, and buzzer sound will on.

Water Level							
Powdered detergent volume(g)	20~40	40~60	60~80	80~100			
Different type of detergent	You may adjust the amount of detergent according to the type of detergent.						

- Too much detergent causes poor rinsing and too little detergent causes poor washing

HOW TO SET CUSTOMIZED PROGRAM

1. PREPARATION

- Install the drain hose. Connect the inlet hose to the faucet and turn on the faucet. Connect plug to socket. Put clothing into washer.
- 2. Press "POWER ON/OFF" button
- 3. Press "PROGRAM" or "ADD." button to choose the program according to the type of clothing.

HOW TO SET CUSTOMIZED PROGRAM

PROGRAM CHOOSING GUIDE					
PROGRAM	Types of Clothes	Operation Status			
		Soak Time(min)	Wash Time(min.)	Rinse Time	Spin Time(min.)
CUSTOM	All kinds of clothes	1 0	1 5	2	6
STANDARD	Normal clothes	0	1 0	2	6
QUICK	Daily clothes	0	1 0	1	3
BLANKET	Blanket or Bulky	0	1 5	2	9
DELICATE WASH	Woolen clothes, knitwear, or sweater	0	5	2	3
TUB CLEAN	Cleaning tubs	0	2 0	1	9

- 4. Press PRESET button to set the preset time:

Preset time display: 6 → 7 → 24 → 0 → 4 → 5 (hours)

(PRESET function does not available for DELICATE wash.)

- 5. By pressing process buttons, you can set desired soak time, wash time, rinse time, and spin time. During the setting, the LED will display as follows:

-Soak time display: 10 → 20 → 30 → 40 (min) → No soaking

(SOAK function does not available for DELICATE wash.)

-Wash time display: 5 → 10 → 15 → 20 (min) → No washing

-Rinse times display: 1 → 2 → 3 → 4 times

-Spin time display: 1 → 3 → 6 → 9 (min) → Stop spinning

(for STANDARD, CUSTOM, BLANKET)

0 → 1 → 3 (min) (for DELICATE)

Note: TUB CLEAN function has default setting of 8th water level, and all processes cannot be adjusted. During "QUICK" all processes cannot be adjusted, only water level and spinning speed can be adjusted.

- To set one unique process: press PROGRAM button to select STANDARD, then press WASH, RINSE or SPIN button to set WASH ONLY, RINSE ONLY or SPIN ONLY.
- 5. Press WATER LEVEL button to select proper water level and then put detergent in.
- 6. Press "START/PAUSE" button and close the washer lid.
- 7. To reset, turn off the washer and turn on again by pressing "POWER ON/OFF" button.

HOW TO USE DELICATE WASH

- Please check the care label before you wash woolen material.
- When this program is set, the water level will be set at 6 automatically. However you can change the water level to 3~8 according to the load size of your clothes.

OPERATION

1. Turn on the faucet, press POWER ON/OFF button and open the wash lid.
2. Press PROGRAM button to select DELICATE.
3. Put liquid detergent, dissolved powder detergent with 5L warm water, (about 30°C) into the washer.
4. Put clothes into the washer.
5. Press START/PAUSE button. If necessary, you can adjust the water level.
6. Close the washer lid.

If the washer lid is not closed, the washer will stop automatically before spinning.

The buzzer will buzz at the end of washing, and power will be automatically off in 5 sec.

Turn off the faucet and clean the filter.

Note:

- Clothes weight should be less than 3.0kg for DELICATE.
- After wash, please remove the clothes for hanging to avoid prolonged stay and deformation.
- PRESET does not function here.
- The water temperature should be less than 30 °C.
- Please wash white, colorful, and dark color clothes separately.

ADDITIONAL FUNCTIONS

PRESET

- It is used to delay the finishing time of the operation.
- Before PRESET, turn on the faucet, connect the drain hose, and make sure the connection of water inlet hose to the faucet is firm to avoid water leakage.

OPERATION

1. Press POWER ON/OFF button.
2. Press PROCESS or PROGRAM to select your desired program..
3. Press PRESET to select the time. LED will display finishing time. Press one more time, the time will be added by 1 hour. The longest is 24 hours.
4. Press WATER LEVEL to select proper water level. Put detergent and softener in.
5. Press START/PAUSE button.
6. Close the wash lid.

-Except for PRESET light, all other lights will off after one minute. If CHILD PROOF function is set, the CHILD PROOF light will be on as well.

-For "DELICATE" "QUICK" and "TUB CLEAN" programs, the preset does not function.

-If you need to check the remaining time, press any button except for POWER ON/OFF.

-If you need to change the preset process, press POWER ON/OFF, repeat the above.

-The PRESET will be cancelled if washer is unplugged or there is power failure.

ADDITIONAL FUNCTIONS

MEMORY

The programs "STANDARD", "CUSTOM" "BLANKET" will be remembered after ending. For next use, turn on power, the washer will display the process of last time. Press START/PAUSE button, to start.

-The washer cannot remember "PRESET" and "WATER LEVEL".

-For "STANDARD" "BLANKET" program, the washer can only remember default programs, while for "CUSTOM", the washer can remember manual setting data, like wash time, rinse times and spin time.

INTELLIGENT WASH

In order to increase wash efficiency, the washer will start washing when water reaches 2 levels less than set water level, at the same time, the water continues to flow in.

-INTELLIGENT WASH is not available for DELICATE and TUB CLEAN. It is not working if 1st or 2nd lowest water level is chosen.

-If SOAK is set, there is no INTELLIGENT WASH function.

WATER LEVEL CHANGE

You can set the water level for wash and rinse processes. For example, if you are sensitive to detergent residues in your wash, you may want to select a higher water level for rinse.

To set different water level:

-Press the WASH button until the WASH indicator light up; press the WATER LEVEL button to choose the proper water level; press the WASH button to set the wash time.

-Press the RINSE button until the RINSE indicator light up; press the WATER LEVEL button to choose the proper water level; press the RINSE button to set the number of rinses.

-Press the SPIN button until the SPIN indicator light up; press the SPIN button to choose the spin time.

-Press the START/PAUSE button to start wash.

CHILD PROOF

This function avoids child open the washer lid.

To set the child proof:

Press POWER ON/OFF, and keep on pressing SPIN SPEED button for 4 seconds until a buzzer sound. The child proof will be activated when the START/PAUSE button is pressed. Repeat the steps to cancel.

With CHILD PROOF mode, the child proof indicator will be on. If the washer lid is open for more than 5 seconds during washer running, the washer will stop running with E5 error display buzzer will keeps beeping.

DELETE THE END BUZZER

Press POWER ON/OFF, and keep pressing START/PAUSE button for more than 4 seconds till a sound from buzzer. To restore, repeat the above steps.

ADDITIONAL FUNCTIONS

DRAINING

Once set, the drain valve opens automatically 9 minutes after machine stops. The remaining water drains to avoid freezing (under 0°C). "Ud" displays on Control Panel.

SETTING METHOD

Press POWER ON/OFF, and Keep pressing "SPIN" for more than 4 seconds until a beep sounds. To recover, repeat the above steps.

TUB CLEAN

This function is to clean the surfaces of outer tub and inner tub. It is suggested to clean every 6 months.

1. Press POWER ON/OFF
2. Put specific detergent or disinfectant product for tub clean into the tub.
3. Press ADD. to select TUB CLEAN.
4. Press START/PAUSE.

Note:

-The default water level is the highest one.

-The whole cleaning process takes about 1 hour.

The water level button and other buttons cannot work.

AIR BUBBLE+

In order to enhance the cleaning performance, during the washing process, the AIR BUBBLE+ generator is generating air bubble.

Press "POWER ON/OFF" button, and press "AIR BUBBLE+" button until a beep sounds, AIR BUBBLE+ indicator will light up, indicating that this function has activate. To restore, repeat the above steps.

(After machine starts, the "AIR BUBBLE+" function is automatically started)

TROUBLESHOOTING GUIDE

When the following problems occur, the microcomputer will detect the abnormal condition and an electronic buzzer beeps for approximately 10 seconds and the indicators flash as shown below.

Problem	Trouble Indication	Where to Check
The washer does not work at all		<ul style="list-style-type: none"> • Check the POWER ON/OFF button. • Check the START/PAUSE button. • Check whether under PRESET condition. • Check whether the power cord is securely plugged in. • Check whether power failure occurs. • Check whether the fuse or circuit breaker of power cord has been activated.
Water does not flow into tub or water flow is low	E1	<ul style="list-style-type: none"> • Turn on the water supply faucet. • Check whether water supply has been cut off. • Check whether the metal filter in water inlet is clogged. • Check whether the water supply hose has been frozen. • Check whether water pressure is too low.
Water does not drain out	E2	<ul style="list-style-type: none"> • Check whether the Drain hose is tipped. • Check the drain hose for any obstructions. • Check whether the drain rises too high off the ground.
The washer does not spin	E3	<ul style="list-style-type: none"> • Check whether the laundry is clumped on one side of tub. • Check whether the washer is on the level surface.
	E4	<ul style="list-style-type: none"> • Close the washer lid.
Does not wash	E5	<ul style="list-style-type: none"> • Check whether the washer is under CHILD PROOF mode. • Check whether the washer lid is open.
Others	EA Eb EC Ed E901 E902 E920 etc	<ul style="list-style-type: none"> • Press the POWER ON/OFF button to turn off power, and contact our service department.

NOTE: The Trouble indicators can be released by pressing the START/PAUSE button once if you want to release the emergency stop. Then press the START/PAUSE button again to restart the operation.

NON-FAULT PHENOMENON

1. During wash or rinse, if water flows in, this is possibly caused by automatic water supplement due to low water level.
2. When spinning, the tub rotates discontinuously. This is intermittent spinning designed for better spin effect.
3. Draining does not happen during rinse. This may be caused by low water level or pressure.
4. Sometimes you may notice that water flows during spin. This is because the machine is correcting the unbalanced load automatically.
5. After spin ends, one may hear sound as if water flows. This is specially designed to reduce vibration in spin by a balance liquid in balancing ring.
6. The machine has to be reset upon restoration of power, after power failure.

SPECIFICATIONS







Dimensions	680(W)x695(D)x1065(H)mm
Net weight	60kg
Water quantity (HIGH)	107L
Input voltage & Frequency	220-240V~50Hz
Power Consumption	300W
Required Water Pressure	0.03 MPa - 0.8 MPa (0.3 kgf/cm ² - 8 kgf/cm ²)

安全注意事项	20~22
保养须知	22
配件说明	23
各部件名称	23
安装介绍	24~26
操作面板功能介绍	27~28
标准程序	29
如何设置自选程序	29~30
柔顺程序的使用方法	31
附加功能介绍及设定方法	31~33
预约功能	31
记忆功能	32
智能洗功能	32
变容洗功能	32
儿童锁功能	33
取消終了蜂鸣音	33
排残水功能	33
洁桶功能	33
超净泡功能	33
故障排除指南	34
并非故障的情况	35
规格	36

- 使用前请仔细阅读【注意事项】并正确使用。
- 为了防止对使用人和他人造成伤害或财产损坏，现就安全方面需要务必遵守的事项，作以下说明：

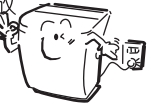
 警告	此标示栏的内容为【有死亡或受伤的可能性】
 注意	此标示栏的内容为【有受伤及仅有物品损坏的可能性】

		
「警告或提醒注意」的内容。	「禁止」的内容。	「注意」的内容。

 警告	
<p>不可改装，非专业维修人员禁止分解及修理洗衣机。</p> <p> • 会造成火灾、触电、受伤。 • 发生故障时请向本公司报修。</p>	<p>请务必正确接地。</p> <ul style="list-style-type: none"> • 为防止漏电事故的发生。 <p> <small>插座良好接地</small></p>
<p>手潮湿时请勿插入或拔下电源线插头。</p> <ul style="list-style-type: none"> • 以避免触电的危险。 <p> <small>禁止湿手</small></p>	<p>洗衣机本体各部分，请勿直接冲洗。</p> <ul style="list-style-type: none"> • 以避免绝缘不良，导致触电的危险。 <p> <small>禁止</small></p>
<p>电源线的保护。</p> <ul style="list-style-type: none"> • 使用时请注意电源线外皮是否损伤，有无不合理弯曲或拉伸及重物压住变形等现象，电源线破损导致绝缘不良，这是发生触电、火灾的原因。电源线损坏时，需由专业维修人员维修更换。 <p> <small>禁止</small></p>	<p>请勿洗涤沾有挥发性溶剂的衣物。</p> <ul style="list-style-type: none"> • 请勿洗涤沾有汽油、煤油、稀释剂等衣物，这样可能引起火灾或爆炸。 <p> <small>禁止</small></p>

安全注意事项

⚠ 警告

不要让儿童在洗衣机上或洗涤/脱水桶内玩耍。

- 如果儿童不慎掉入洗涤脱水桶内，会产生严重的伤害。
- 该电器不适用于人群（包括儿童）：具有身体障碍、感官障碍、精神障碍者，或缺乏必要经验与常识者，必须要在安全监护人的指导和监督下才能使用。



禁止

当洗衣机运转时，不要将手伸进洗涤脱水桶，

- 如果手碰到洗涤脱水桶可能会受到伤害。
- 脱水时，如果洗涤上盖打开15秒内，洗涤脱水桶不停转动，请立即关掉电源，并尽快拨打本公司客户服务电话。



禁止触摸



单独使用一个插座并确保插座符合指定电压与电流。

- 插座松动或与其它电器产品共用同一插座可能因发热而引起火灾。



电源线插头的灰尘等要定期清除。

- 电源线插头上若灰尘堆积，会因湿气造成绝缘不良引起火灾。

避免安装于潮湿及雨淋处。

- 电器绝缘会不良，成为漏电或故障的原因。



禁止

请勿靠近烟火

- 请勿靠近烟火，且勿将点燃的蜡烛、香烟、蚊香及水壶放在洗衣机上，这是造成火灾或变形的原因。



禁止

⚠ 注意

- 电源线插头插入或者拔出时，手指须紧握插头绝缘部分施力，请勿触碰插头的金属插片，以避免触电或施力于导线端，导致电源线内部导线断裂。

- 在移动洗衣机时，务必先拔下电源线插头。



禁止

- 请勿使用温度超过50℃的水洗涤，以避免由于塑料变形造成触电或漏电。



禁止



保养时，请务必从插座上拔下电源线插头，此外，手潮湿时不可插拔电源线插头。

- 会造成触电、受伤。

- 长时间不使用洗衣机时，请拔掉电源。
- 可能会因为漏电或者触电造成塑料件变形。
- 如果电源线损坏，为了避免危险，必须由生产商、其代理商或专业人员更换。



安全注意事项

⚠ 注意

防水性或不吸水的洗涤物不可以放入洗衣机内洗涤。

- 以避免洗衣或脱水时，产生异常震动。（如：雨衣、车套）

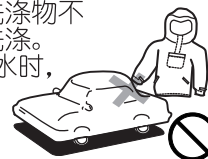

禁止

- 请勿将幼儿及重物放置在洗衣机上。以避免部件变形或破损导致危险的发生。



禁止

- 洗衣机运转中，请切勿尝试接触内部运作部件。以避免受伤的危险。

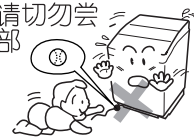

禁止触摸

- 洗涤之前检查供水软管连接处。螺钉松开或不紧密可能造成漏水。

- 请使用电器附带的新的软管装置，旧的不可重复使用。
- 洗衣机安放在地板或弹性较大支撑台上时，可能会造成洗衣机的振动。



- 供水管应拧紧，否则可能会导致漏水。水管接口处长时间使用可能会导致螺母松动造成漏水，请检查时再次拧紧。

漏水

洗衣机不使用时

- 应关闭水龙头，以避免进水软管破损或脱落，造成漏水事故的发生。
- 应将电源线插头拔掉，以防止发生火灾或其他事故。



拔掉插头

保养须知

使用软布擦除箱体上的水及污迹

- 不要将水直接泼洒在箱体上，这样做可能会造成短路或触电。
- 不要使用刷子、上光粉、汽油或其他易挥发性材料擦拭洗衣机。这样做可能会损坏机身表面涂层或塑料部件。



进水阀口的清理（建议半年一次）

- 脏物积存会影响进水量，请取下进水软管，取出进水阀口的过滤网，清除网上的脏物后重新装回。



进水阀口

接头的清洗（建议半年一次）

- 取下进水软管。
- 按箭头方向旋下万能接头。
- 取出万能接头内的过滤网，用牙刷等清洗干净。
- 将清洗干净的过滤网装入万能接头，将万能接头、进水软管重新装上。



万能接头

过滤网

过滤网的清洗（每次用完及时清洗）

- 取下过滤网。
- 去除大块毛绒，同时刷去过滤网上的细小绒毛。
- 重新装上过滤网，安装时将框部的爪对准下方的沟部放入。



配件说明

说明书	排水软管	进水软管	万能接头	底盖板	螺钉	排水软管挂钩
						

各部件名称

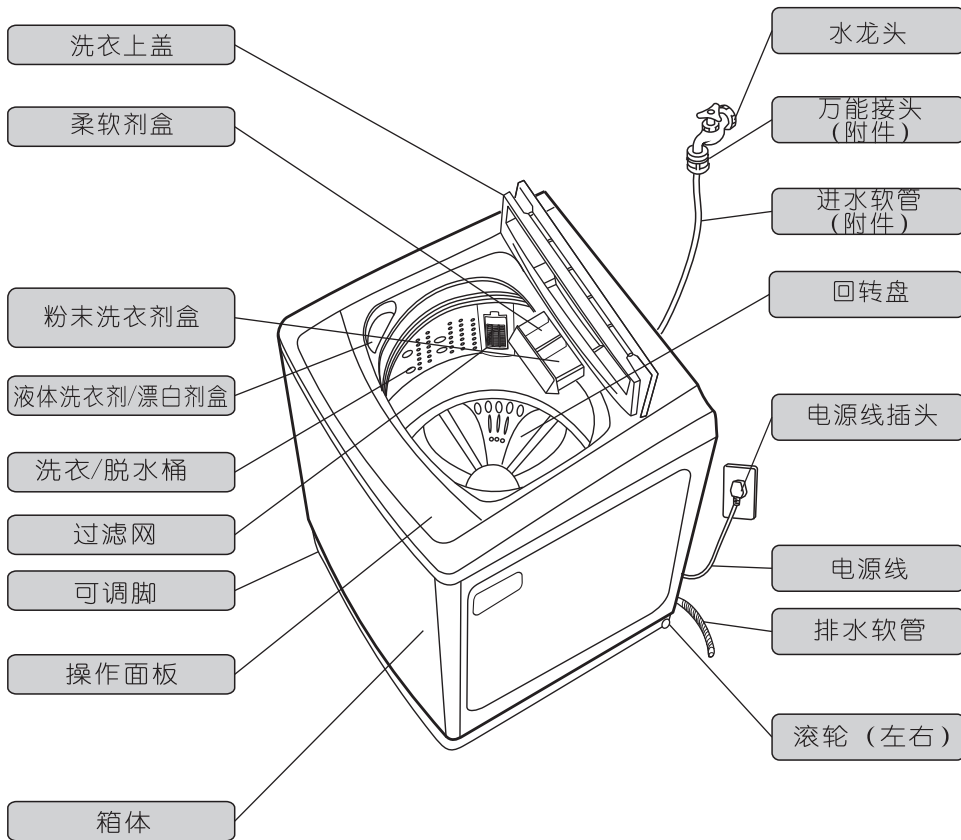

安装介绍

底盖板的安装

1. 拿出洗衣机面架保护上的底盖板和部件袋中的螺钉。
2. 将洗衣机向后倾斜，慢慢地放倒在软垫上。
3. 将底盖板沿底座卡槽笔直推入，直至其安装到位。
4. 用螺钉将底盖板与底座固定。
5. 将洗衣机轻轻扶起，放稳。

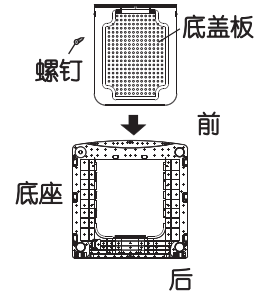

洗衣机的放置

1. 选择干燥、无阳光直射的地方放置洗衣机。
2. 将洗衣机安放在坚实、平稳的地面上。
3. 尽量使洗衣机平稳，如有必要，可按照图示顺序通过调节洗衣机的可调脚来将洗衣机调平。洗衣机放置面最大允许倾斜度为2°。

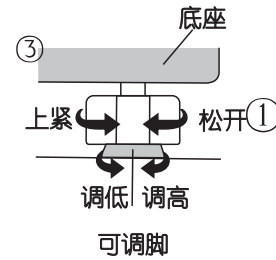

水龙头的选用

水龙头类型：（水龙头口部要平整）

A型：最为合适。

B型：水龙头长度须大于16mm，否则无法安装万能接头。

C型：如图所示部位可能会出现漏水现象。

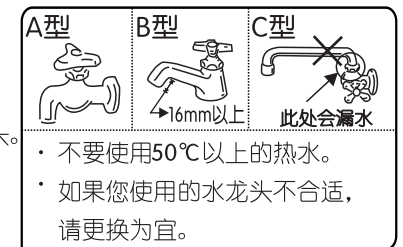

安装介绍

万能接头的安装

- 一手拿着万能接头，一手按住锁紧杆，将万能接头与进水软管分开。
- 如果水龙头的直径大于万能接头中环垫的内径，请先松开万能接头上的螺钉，将环垫取出。
- 均匀调整万能接头上的4枚螺钉，使靠墙侧的2枚螺钉首先与水龙头外侧充分接触。
- 将万能接头垂直套到水龙头上，使其内部的密封圈紧贴在水龙头的口部，用螺丝刀拧紧4枚螺钉。
- 撕下万能接头上的封条，旋紧万能接头。

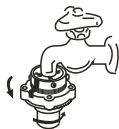
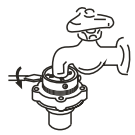
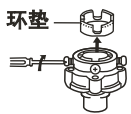

进水软管的连接

- 将进水软管与万能接头连接。
- 将进水软管口对准进水阀口，顺时针旋转进水软管上的旋紧螺母，直至旋不动为止。
- 确认进水软管连接是否牢固
 - 向下拉拽进水软管，确认进水软管与万能接头连接可靠，然后慢慢打开水龙头，检查是否漏水。如果漏水，请关闭水龙头，重新安装。
 - 长时间使用后，万能接头可能会松动，此时请重新安装。
 - 洗衣程序结束或长期不用时，请关闭水龙头。



进水软管的取下

- 关闭水龙头。
- 按下“电源开/关”键，接通电源，然后按“启动/暂停”键。
- 15秒钟后，切断电源。
- 用手指按压锁紧杆及套管向下拉，取下进水软管。
- 进水阀上的进水软管按逆时针方向旋转，直至取下进水软管。

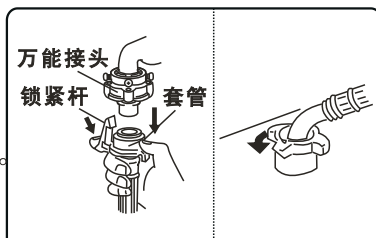

排水软管的连接

将排水软管连接到排水口，然后用软管卡簧将其固定。

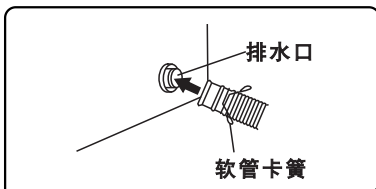

安装介绍

排水软管的延长

当排水软管长度不够时，请向销售商或本公司购买排水软管，进行对接即可。

排水软管的延长	延长高度	延长长度
中间有台阶	15cm以内	1m以内
中间无台阶	—	3m以内

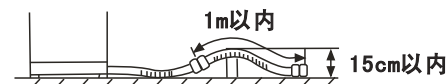

排水软管挂钩的安装

- 在安装排水软管挂钩之前，请先根据需要调整好排水软管的方向。
- 将排水软管挂钩粘贴于洗衣机排水软管所在一侧的面架或箱体的合适位置。
- 当洗衣机不使用时，请将排水软管挂起。

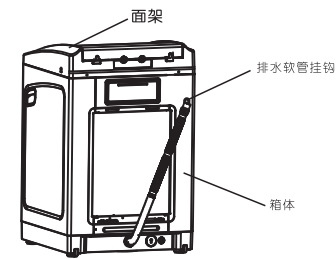

滚轮的使用方法及其注意事项

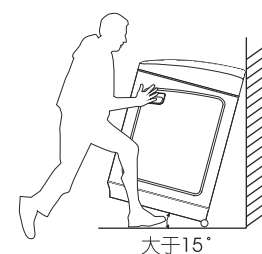
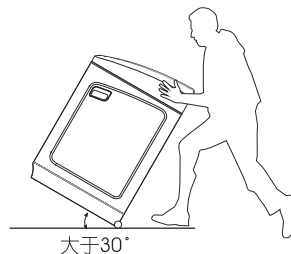

使用移动滚轮来帮助您将洗衣机搬运到想要的位置。

- 请您位于洗衣机后侧，用手按在面架后部，将洗衣机倾斜后，按着机器两侧向前推动或向后拉动洗衣机。
- 移动滚轮搬运中不适于凹凸不平的地面，易造成移动滚轮损坏。
- 倾斜洗衣机时请勿用力过猛，易造成洗衣机倾斜而造成人身伤害。

控制面板功能介绍

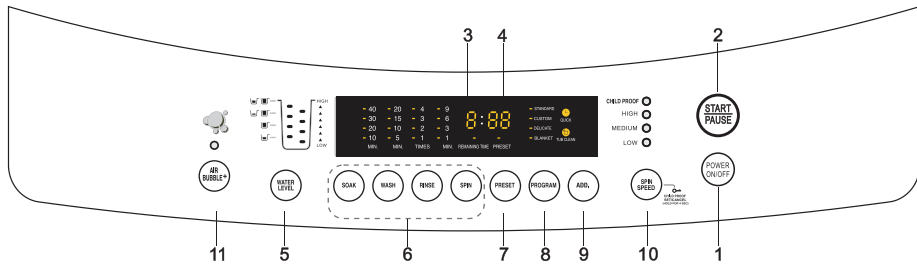

1. “电源开/关”键

- 要接通洗衣机电源，请按该键；要切断电源，再按该键一次即可。按该键后，10分钟内没有按其它键，电源将自动切断。程序运行结束后，电源会在5秒钟之后自动切断。

2. “启动/暂停”键

- 按下“电源开/关”键，接通电源，然后按该键，洗衣机开始运转。该键可用于暂时停止运转。如要重新开始运转，只需再按该按键。

3. 数码窗

- 程序设定后，屏幕显示程序、洗衣时间、漂洗时间、脱水时间等设定。

4. 数码显示区

- 运转过程中显示剩余时间。
例：剩余时间为20分：----- 20。
- 预约设定过程中，显示预约行程何时完成。
例：剩余时间为2小时：----- 2
- 发生异常时，显示故障代码。
例：不进水：----- E1

注意：对于显示E901等四位故障代码时，数码显示区将会交替闪烁显示故障代码。

5. “水位”键

- 通过该键选择与洗涤衣物相合适的水位。洗涤和漂洗可以用不同的水位。“柔顺”程序不能选择最低两档水位。

控制面板功能介绍

6. “过程”键

您可以根据需要，通过该组按键自由设定浸泡时间、洗涤时间、漂洗次数、脱水时间。

- 如果在启动前按“浸泡”键，可设定0~40分钟动态浸泡时间。（选择“柔顺”、“洁桶”时，不能设定）。
- 正在运行的过程相应的灯会闪烁显示。

7. “预约”键

- 用于设定从预约程序开始到洗涤完成的时间。
- 按该按键后，数码窗的“预约”灯闪烁，数字显示预约小时数。
- 选择“柔顺”“快洗”“洁桶”程序时，不能设定“预约”功能。

8. “程序”键

- 您可以通过按“程序”键来选择“标准”、“自选”、“毛毯”、“柔顺”四种全自动程序。
- 注意：如果您选择“标准”、“自选”、“毛毯”程序，洗衣机将自动进行模糊判断，自动选择合适的水位和水流等。

9. “附加程序”键

- 根据您的衣物多少和脏污程度可以自由选择“快洗”、“洁桶”程序。
- 注意：如果您选择“快洗”程序，洗衣机将自动进行模糊判断，自动选择合适的水位和水流等。

10. “转速”键

- 用于设置脱水转速，使用个别程序时，脱水转速选择范围会受限制。也可设置儿童锁功能，具体操作见童锁功能描述。

11. “超净泡”键

- 如果需要超声波功能，您可以开始前按此键设置。（洗衣机开机后，“超净泡”功能默认已启动）

标准程序

1. 准备

①接好并放好排水软管。

②将进水管接到水龙头上,并拧开水龙头。

●拧开水龙头之前,需确认进水管与水龙头已拧紧。如果未拧紧,可能会造成漏水。

③将电源线插头插入电源插座。

④放入洗涤物。

2. 按“电源开/关”键。

3. 按“启动/暂停”键。







●传感器自动检测布量(“标准”、“自选”、“快洗”、“毛毯”程序时)。

●自动选择水流、水位。

4. 参照下表将洗涤剂放入洗涤剂盒或洗涤/脱水桶内。

5. 盖好洗涤上盖。

●如洗涤上盖没有关闭,洗衣机将会在脱水运行之前自动停止运转并伴有报警声。

水位							
粉末洗涤剂用量(g)	20~40	40~60	60~80	80~100			
其他类型洗涤剂	按相应洗涤剂说明对照使用						

●洗涤剂用量过多可能会漂洗不彻底,而过少则洗涤不干净。

如何设置自选程序

1. 准备: 放好排水软管, 拧开水龙头, 将电源线插头插入电源插座, 放入洗涤物。

2. 按一下“电源开/关”键。

3. 根据所洗衣物的种类, 按“程序”或“附加程序”键设定您想要的程序。

如何设置自选程序

●各程序选用参见下表

各程序的选用指导					
程序	适合衣物的类型	浸泡时间	洗涤时间	漂洗次数	脱水时间
自选	各种衣物(根据自己的喜好)	10分	15分	2	6分
标准	一般日常的洗涤物	0分	10分	2	6分
快洗	每天换洗不脏的衣物	0分	10分	1	3分
毛毯	毛毯或大物	0分	15分	2	9分
柔顺	柔顺、饰有花边和刺绣的衣物	0分	5分	2	3分
洁桶	清洗洗衣桶	0分	20分	1	9分

4. 通过按“预约”键可以设定预约时间, 如下:

●预约时间设定显示: 6→7→……24→0→4→5 小时 (“柔顺”程序不能设定“预约”功能)

5. 通过按“过程”的一组按键, 可以自由设定浸泡时间、洗涤时间、漂洗次数、脱水时间。设定时, 显示屏中数字循环显示如下:

●浸泡时间设定显示: 10→20→30→40分钟→无浸泡 (“柔顺”程序时不能设定)

●洗涤时间设定显示: 5→10→15→20分钟→无洗涤

●漂洗次数设定显示: 1→2→3→4次

●脱水时间设定显示:

1→3→6→9分钟→停止脱水 (“标准”、“自选”、“毛毯”程序)

0→1→3 分钟 (“柔顺”程序)

注: “洁桶”程序预设8档水位, 并且不可调节, 以上过程均不可设置。

快洗过程参数不可调, 可调水位转速。

●单一过程的设定: 按“程序”键, 选择“标准”程序, 然后按“洗涤”、“漂洗”或“脱水”键, 可直接设定单洗涤、单漂洗或单脱水功能。

6. 按“水位”键, 选择适当的水位, 放入洗涤剂。

7. 按“启动/暂停”键。

8. 盖好洗涤上盖。

●如果您想改变已设定好的“程序”及“过程”。请关掉电源开关再打开, 并重新选择您所需要的程序。

柔顺程序的使用方法

- 用于羊毛纤维等质地的衣物洗涤，洗涤前请确认衣物的洗涤图示标志。
- 用该程序时，水位自动设在第6档。但您可根据羊毛服装的大小改变水位，设置成第3~8档。

操作顺序

1. 拧开水龙头，按下“电源开/关”键并打开洗涤上盖。
2. 按“程序”键，直到“柔顺”灯亮为止。
3. 将液体洗涤剂倒入洗衣机，如您使用洗衣粉，将其充分溶解在5L的温水中（大约30℃），然后慢慢地倒入洗衣机中。
4. 将羊毛服装放入洗衣机内并按入水里。
5. 按“启动/暂停”键。（根据需要，可人工调整水位。）
6. 盖好洗涤上盖。
 - 如洗涤上盖没有盖好，洗衣机将会在脱水运行之前自动停止运转。
 - 在洗涤完成之后，蜂鸣器将发出鸣叫，电源将在5秒钟后自动切断。
 - 洗完 after，关上水龙头并清洗过滤网。

注意

- “柔顺”程序额定洗涤容量应在3.0kg以下。
- 程序完成后，请速将衣物取出，整形晾晒，以免放置时间过长而变形。
- 不可预约洗涤。
- 为了防止衣物的损伤，洗涤水温不应超过30℃。
- 请将白色或明亮色彩的衣物与深色衣物分开洗涤。

附加功能介绍及设定方法

预约功能

- 预约洗涤设定的时间是程序完成的时间。
- 预约设定前，首先要拧开水龙头，放好排水软管，检查进水软管与水龙头是否拧紧，防止发生漏水事故。

操作顺序

1. 按“电源开/关”键。
2. 按“程序”或“过程”键选择程序或过程。

附加功能介绍及设定方法

3. 按“预约”键，设定预约完成时间，数码窗显示设定的时间，每按一次增加一小时，最长时间为24小时。
4. 必要时，用“水位”键设定合适的水位。放入洗涤剂、柔软剂等。
5. 按“启动/暂停”键。
6. 盖好洗涤上盖。
 - 约一分钟后，除“预约”指示灯外其余灯全部熄灭，如果设置了儿童锁，则儿童锁灯一直亮。
 - “柔顺”和“洁桶”程序不能设定预约洗涤。
 - 想要查看预约过的程序，请长按除“电源开/关”键以外的任意键。
 - 要变更预约程序，请关掉电源，重新开机设定。
 - 拔下电源线插头或停电后，预约即被取消。

记忆功能

- 当选择“标准”、“自选”、“毛毯”程序时，程序结束后，洗衣机将记住你所选的程序，下次使用时，打开电源，即显示上次使用的程序，只要按“启动/暂停”键，即可开始工作。
- “预约”、“水位”的设定不记忆。
 - “标准”、“毛毯”程序只记忆默认程序，而“自选”程序可记忆“洗涤”“漂洗”、“脱水”过程人工设定的参数。

智能洗功能

- 为了提高洗涤剂的浓度，在洗涤过程中，当进水到比设定水位低两档时，进水同时开始洗涤。
- 设定最低两档水位和“柔顺”程序时，无智能洗功能。
 - 选择“浸泡”时，浸泡后洗涤无智能洗功能。

变容洗功能

为了提高洗涤浓度，同时也可以节约用水，洗涤、漂洗可以设定不同的水位，建议以较低的水位洗涤，较高的水位漂洗，这样可以保证洗的干净，漂的彻底。

设定方法

按“洗涤”键直至“洗涤”灯亮，用“水位”键选择您想要的洗涤水位，按“洗涤”键设定洗涤时间；按“漂洗”键直至“漂洗”灯亮，再用“水位”键选择您想要的漂洗水位，按“漂洗”键设定漂洗次数；再按“脱水”键直至“脱水”灯亮，按“脱水”键设定脱水时间；启动后，洗涤和漂洗将分别按照您设定的不同水位进行脱水。

附加功能介绍及设定方法

儿童锁功能

为了防止儿童打开洗衣机洗涤上盖造成伤害，可设置儿童安全锁功能。

设定方法

按“电源开/关”键，接通电源后按住“转速”键不放4秒以上，直到听到蜂鸣提示音为止。表明已启用“儿童安全锁”功能。取消时，重复上述操作。

- 设置“儿童安全锁”功能后，操作面板“儿童锁”灯点亮，如洗涤过程中打开洗涤上盖超过5秒，洗衣机将停止工作并出现“E5”和蜂鸣提示音报警。

取消蜂鸣声

取消方法：按“电源开/关”键，接通电源后按住“启动/暂停”键不放4秒以上，直到听到蜂鸣提示音为止。恢复时，重复上述操作。

排残水功能

设置后，在程序结束9分钟后，排水阀自动打开，排出机内残留的水，防止天冷时冻结。（在气温低于0℃时使用）。排残水功能作用时，数码框显示“Ud”。
设置方法

按“电源开/关”键，按住“脱水”键4秒以上，直到听到蜂鸣提示音为止。恢复时，重复上述操作。

洁桶功能

本程序是对洗衣机内外桶的回转盘内表面进行清洗、杀菌。
（专功能是对桶的清洗，建议6个月进行一次）

操作顺序：

1. 按“电源开/关”键
2. 在洗衣桶内加入专用清洗剂或消毒液，并盖好洗衣上盖。
3. 按“程序”键选择“洁桶”。
4. 按“启动/暂停”键。
 - 水位自动设定为高水位。
 - 程序运行时间约1小时。
 - 此时水位等键均不能设定。

超净泡功能

为了提高清洁性能，在洗涤过程中，“超净泡”发生器产生气泡。
● 按下“电源开/关”键，然后按“超净泡”按钮，直到发出哔哔声，“超净泡”灯点亮，表明已启用“超净泡”功能。恢复时，重复上述操作。（洗衣机开机后，“超净泡”功能默认已启动。）

故障排除指南

当下列问题出现时，微电脑将对不正常状态进行检测，并发出大约10秒钟的电子蜂鸣提示音报警，数码窗将按下表所示状态显示。

故障种类	故障显示	原因
完全不运转		<ul style="list-style-type: none"> ● 电源是否接通？ ● 是否按了“启动/暂停”键？ ● 是否在预约状态？ ● 电源线是否插牢。 ● 电源的保险丝或电流断路器是否完好？ ● 是否停电了？
不进水或进水量很少	E1	<ul style="list-style-type: none"> ● 水龙头是否打开？ ● 是否停水？ ● 进水软管及进水阀过滤网是否发生堵塞？ ● 洗衣机进水软管是否已经冻结？ ● 水压是否太小，进水时间过长？
不排水	E2	<ul style="list-style-type: none"> ● 排水软管是否放倒？ ● 排水口是否过高？ ● 排水口是否被堵塞？
不脱水	E3	<ul style="list-style-type: none"> ● 洗涤物是否偏向洗涤/脱水桶一侧？ ● 洗衣机安放是否平正？
	E4	<ul style="list-style-type: none"> ● 洗涤上盖是否打开？
不洗涤	E5	<ul style="list-style-type: none"> ● 检查儿童安全锁功能是否设置？ ● 洗涤上盖是否打开？
其它	EA Eb EC	<ul style="list-style-type: none"> ● 请按“电源开/关”，关闭电源，拔下电源线插头，并尽快拨打本公司客服电话。
	Ed	
	E901 E902 E920 等	

注意：

按“启动/暂停”键，故障显示被解除。如您检查各项并排除故障后，再按“启动/暂停”键，洗衣机将继续运转。如仍有异常，请拔下电源线插头，并尽快拨打本公司客户服务电话。

并非故障的情况

1. 在洗涤或漂洗时有时有进水现象, 这是由于水位下降而进行的自动补水。
2. 在脱水开始时, 洗涤/脱水桶时停时转, 这是为达到更好的脱水效果而设计的间歇脱水。
3. 注水洗清时, 排水管有不排水现象, 这是由于设定水位较低或水压较小造成的。
4. 脱水中途有时出现进水漂洗现象, 这是由于脱水时衣物偏置而自动进行的脱偏纠正。
5. 脱水结束后, 有水残留的声音, 这是为了降低脱水振动而设计的平衡环内平衡液的流动声。
6. 运转中途停电, 来电后不能自动进行继续运行, 请重新设定。

规格

外形尺寸:	680(W)x695(D)x1065(H)mm
净重:	60kg
额定最大洗衣用水量:	107L
额定电压/频率:	220-240V~50Hz
额定输入功率:	300W
水压:	0.03 MPa - 0.8 MPa (0.3 kgf/cm ² - 8 kgf/cm ²)