

SHARP



Refrigerant; R600a
Insulation blowing gas; Cyclopentane

CHEST FREEZER OPERATION MANUAL CONTENTS

- SAFETY PRECAUTIONS.....1-3
- HOW TO USE.....4
- CLEANING.....5
- BEFORE REQUESTING SERVICE.....6
- WARNINGS.....7
- PART NAMES AND FUNCTIONS.....8-9
- TEMPERATURE ADJUSTMENT.....10
- SPECIFICATIONS.....10

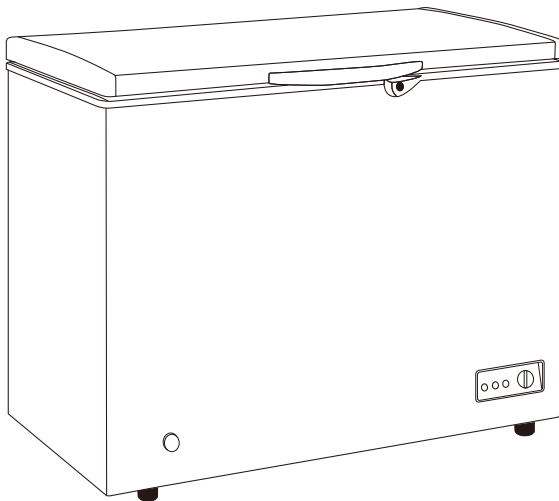

SJC118	SJC228
SJC128	SJC318
SJC168	SJC328
SJC178	SJC518
SJC218	SJC528

WARNING

- Repairs should be performed by qualified service personnel only.
- Keep ventilation opening, in the appliance enclosure or in the built-in structure, clear of obstruction.
- Do not use mechanical devices or other means to accelerate the defrosting process, other than those recommended by the manufacture.
- Do not damage the refrigerant circuit.
- Do not use electrical appliance inside the food storage compartments of the appliance, unless they are of the type recommended by the manufacture.

SAFETY PRECAUTIONS 1

- Please thoroughly study these SAFETY PRECAUTIONS before operating the unit.
- The purpose of the SAFETY PRECAUTIONS in this manual is to :
 1. ensure safe and proper use of the unit
 2. prevent risks that could lead to serious injury to you or other
- The safety precautions are divided into WARNINGS and CAUTIONS. In both cases, improper handling of the unit could result in death or serious injuries. To ensure your safety and the safety of others, please adhere strictly to both.

 **WARNING** Improper handling of the unit could lead to death or serious injury.

 **CAUTION** Improper handling of the unit could lead to serious results depending on the circumstances.

- Text set off by the exclamation mark  contains information that should be strictly adhered to.
- After reading the instruction manual, store it in an easily accessible place where the user(s) of this product can easily find it.

◆ PRECAUTIONS FOR INSTALLATION

WARNING



Installation should be performed only by the dealer or a qualified expert. Attempting to install the unit yourself could result in water leakage, refrigerant leakage, electrical shock, or fire.

◆ PRECAUTIONS FOR USE

WARNING



DONT TAMPER

All repairs, disassembly and modifications should be performed only by qualified technicians. Attempting to perform these yourself could result in a fire, malfunction, and injury.

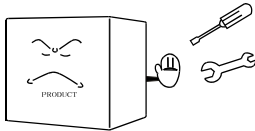

ELECTRICAL SHOCK HAZARDS

Never splash water directly onto the product or wash with water as it could result to short-circuit and electrical leakage

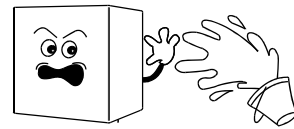

DANGER OF EXPLOSION

Never put flammable or volatile substances into the unit as it could result to explosion or fire.

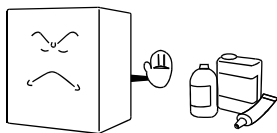

PROHIBITED

Do not damage, modify, excessively bend, strain, twist or bundle up the power cord. Also, placing heavy objects on the power cord or squeezing it in a tight place could damage it, resulting in electrical shock or fire.

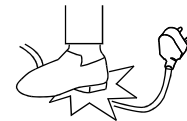

PROHIBITED

Use a dedicated wall outlet. Do not use extension cords or convenience receptacles as this could lead to electrical shock, overheating and a fire.

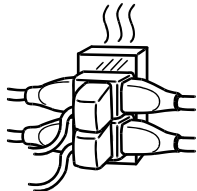

FLAMMABLE

Never use flammable spray cans or flammable substances near the unit. Sparks from electrical switches could result in explosion and fire.

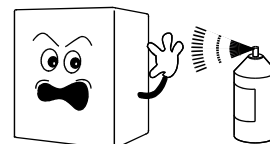

SAFETY PRECAUTIONS 2

⚠ WARNING



Do not store bottles and cans in the unit. The contents could freeze and containers would break and cause injury.

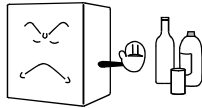

The unit is intended for storage of ice-cream and frozen foods . Storage of other items than the intended could have an adverse affect on the items stored in the unit.

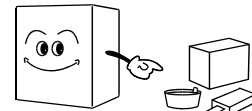

Ice cream, frozen foods



For indoor use only. Using the unit in a location exposed to rain could result in electrical leakage and electrical shock.

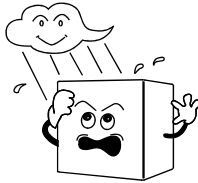

Never place heavy objects or items containing water on top of the unit. Objects could fall down and cause injury, spilled water could deteriorate the insulation of electrical components and result in electrical leakage.

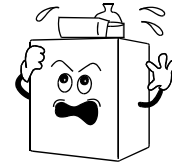

Install the unit in a location where the floor is sturdy enough to support the load of the unit. If the floor is not sturdy enough or installation is incorrectly performed, the unit could tip over or falling shelves and products could cause personal injury.

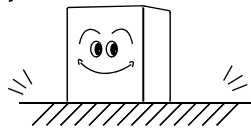

If you find gas leakage, please don't touch the chest freezer, close gas and open the door for ventilation. Gas leakage can cause explosion, fire, and fire injury.

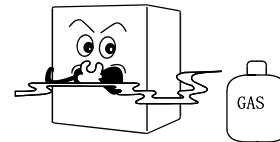

Store the unit in a location where it is not exposed to rain. Using a unit that has been exposed to rain could result in electrical leakage and electrical shock.

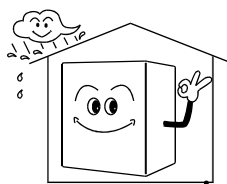

Store unit away from hot air sources Cooling performance is reduced if the unit is placed near heat sources such as hot plates and stoves and if exposed to direct sunlight.



Leave disassembly and disposal of the unit to qualified experts.

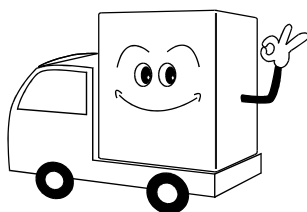

Should the unit need temporary storage, make sure to store the unit away from where children play and take Precautions that the door cannot be completely closed. This will minimize the risk that a child becomes trapped inside the compartment.

SAFETY PRECAUTIONS 3

⚠ CAUTION

WELL VENTILATED PLACE

Please keep a minimum of 10cm space between Chest freezer and wall. If there are no space, cooling capacity can drop down.

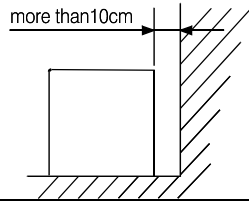

If installation in a damp location is unavoidable, please install an electrical leakage circuit breaker. If no electrical leakage circuit breaker is installed, electrical shock could result.

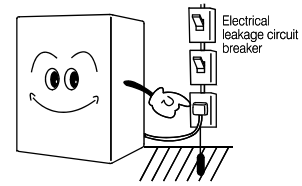

PROHIBITED

Never hang from the door or climb onto the unit. The unit could tip over or fall and cause material damage or personal injury.

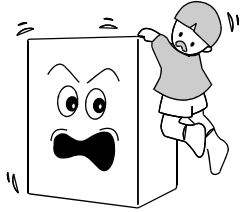

DISCONNECT POWER CORD PLUG FROM WALL OUTLET

Disconnect the power cord plug from the wall outlet before moving the unit and make sure that the power cord is not damaged during transport. A damaged power cord could result in electrical shock and/or fire.

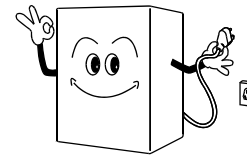

PROHIBITED

Never touch the power cord plug, other electrical components, or operate the switch with wet hands. Electrical shock could result.

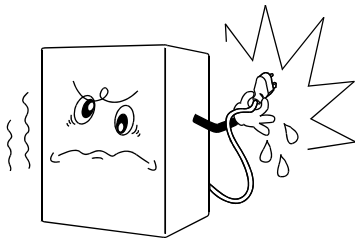

PROHIBITED

Never use if the power cord or plug is damaged or if the plug cannot be firmly seated in the receptacle sockets as it could result to electrical shock, short-circuit and fire.

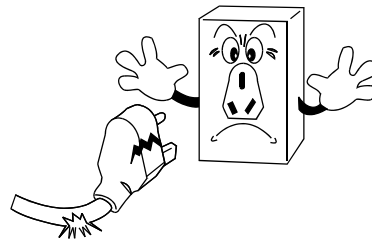

When disconnecting the power cord plug from the wall outlet, hold at the plug's main body. Do not pull the cord, which could cause wire breakage, possible resulting in overheating and fire.

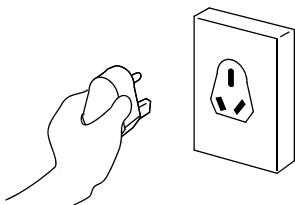

Make sure that the unit does not tip over or fall when it is moved. A falling unit could cause serious injury.

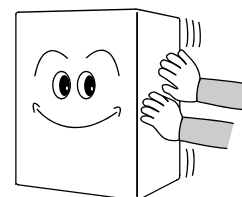

HOW TO USE

BEFORE USE

- Remove shipping packaging, tape, etc. and leave lids open for ventilation for a while.
- The unit is cleaned before shipment. However, clean the compartment interior again after delivery.
- Following installation, refrigeration will start about 10 minutes after operation is started.
- Operate for about 2 hours to cool the refrigerator compartment before placing items in the freezer.

WAIT 5 MINUTES OR MORE BEFORE RE-STARTING

- Restarting the unit immediately after it has been turned off may cause fuses to blow and activate the circuit-breaker, the compressor may be overloaded, and/or other damage may occur.

DEFROSTING

When 5mm frost forms in the freezer, please shave it and throw it away.

To defrost completely, please do it as follows.

- ① Remove all contents, and disconnect the power cord plug.
- ② When frost starts thawing, please shave it to reduce defrost time.
- ③ Drain water and wipe the inside with dry cloth, then replace the rubber cap on the drain bolt and inside drain.



WARNING

For defrosting chest freezer, don't use a hammer, knife, or bottle, which will damage the inside evaporator,

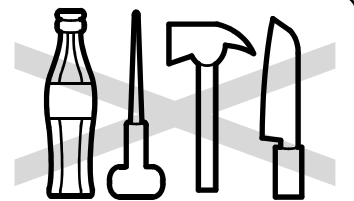

CLEANING



To prevent any electrical shock hazards or injury by rotating circulation fan, always disconnect the power cord plug from the wall outlet before cleaning.

1 EXTERIOR AND COOLER COMPARTMENT

Wipe with a soft, dry cloth. If very soiled, wipe with a cloth that has been moistened with a mild detergent. Then wipe cleanly with damp cloth.



WARNING: Do not splash water directly onto the cooler and do not wash with water. Short-circuit and electrical shock could result.

- Clean the cooler regularly to keep it clean at all times.
- Never use polishing powder, soap powder, benzene, oil or hot water as these will damage the exterior plastic components.

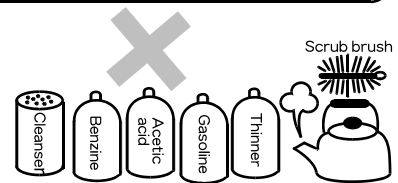

2 DOOR

- Detach the door and wipe cleanly with a dry cloth.

IN CASE OF THE FOLLOWING

1 POWER FAILURE

- Sudden power failure
Keep opening and closing of the door to a minimum to prevent cold air from escaping. Covering exterior glass surfaces with a blanket, etc. Will further help to maintain a low temperature.
- Announced power suspension
In case of a long power suspension, place dry ice in the freezer compartment.
- Keep opening and closing of the door to a minimum.
- Avoid placing new items into the cooler as this will raise the temperature inside the compartment.

2 WHEN NOT INTEND TO A LONG PERIOD

- Remove all items from the compartment and disconnect the power cord plug from the wall outlet.
- Clean the compartment interior and wipe away all water.
To prevent mold formation and bad odor, leave the door open to dry the compartment completely.

3 WHEN NOT USED TEMPORARILY

- Please stick wood between door and chest freezer.
- Please do not put chest freezer near where children can play, to prevent children from trapping inside.

BEFORE REQUESTING SERVICE

Please check the following items if you encounter problems with the unit. If the problem continues after taking the proper remedial actions, disconnect the power cord plug from the wall outlet. Transfer the items stored in the cooler to a box or other container. Then contact the dealer from whom you purchased this unit and be ready to provide information as listed in "REQUIRED INFORMATION" below.

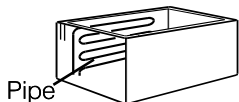

To prevent any electrical shock hazards, do not disconnect the power cord plug from the wall outlet with wet hands.

<p>No refrigeration at all</p>	<ul style="list-style-type: none"> ● Is the power supply interrupted? ● Is the power cord plug disconnected from the wall outlet? ● Are the power fuses blown and/or the circuit breaker activated? ● Is the temperature control dial turned to OFF?
<p>Inadequate refrigeration</p>	<ul style="list-style-type: none"> ● Is the place of installation badly ventilated? ● Is the freezer exposed to direct sunlight, placed near a heater or stove? ● Are the lids opened and closed frequently? ● Are items stocked beyond the load line? ● Is the temperature control dial turned to MIN? ● Much frost formed in the chest freezer?
<p>Excessive noise</p>	<ul style="list-style-type: none"> ● Is the floor underneath the freezer sturdy enough? ● Is the unit shaking and rattling? ● Is the rear panel of the unit touching the wall, etc.? ● A container or something is behind the chest freezer? <p>The compressor will generate a rather loud sound for a while after operation is started. These noise is cease.</p>
<p>Condensation on cooler exterior</p>	<ul style="list-style-type: none"> ● Condensation may collect on the exterior and door during hot and humid days or depending on the place of installation. This occurs when the humidity is high and water particles in the air contact cold surfaces. This is normal. wipe away condensation with a dry cloth.
<p>The circumference of chest freezer feels hot</p>	<ul style="list-style-type: none"> ● Especially in summer or initial operation, the circumference of chest freezer can feel hot, because chest freezer inside has a pipe for radiating and preventing condensation. The heat has no effect on inside goods. <div style="text-align: right;">  </div>

Appliance sometimes stop running when thermostat turns off.

REQUIRED INFORMATION

- | | | | |
|---|---|--------------------------------------|--|
| <p>① Nature of malfunction
(as accurately as possible)</p> <p>② Product number</p> <p>③ Serial number</p> | } | <p>(inscribed on shipping label)</p> | <p>④ Customer's name, address,
phone number</p> <p>⑤ Year and date of purchase</p> <p>⑥ Desired date for service visit</p> |
|---|---|--------------------------------------|--|

WARNINGS

- Damaged supply cord must be replaced by a special cord or assembly available from the manufacturer or its service agent.
- Damaged supply cords must be replaced by the manufacturer, service agent or similarly qualified person To avoid a hazard.
- Keep ventilation openings in the appliance enclosure or in the built-in structure, clear of obstruction.
- Do not use mechanical devices or other means to accelerate the defrosting process, other than those recommended by the manufacturer.
- Do not damage the refrigerant circuit(applicable only for appliances with refrigeration circuits which are accessible to the user).
- Do not use electrical appliances inside the food storage compartments, unless they are the type of recommended by the manufacturer.

PART NAMES AND FUNCTIONS

Model No : SJC118 SJC128 SJC168 SJC178 SJC218
SJC228 SJC318 SJC328 SJC518 SJC528

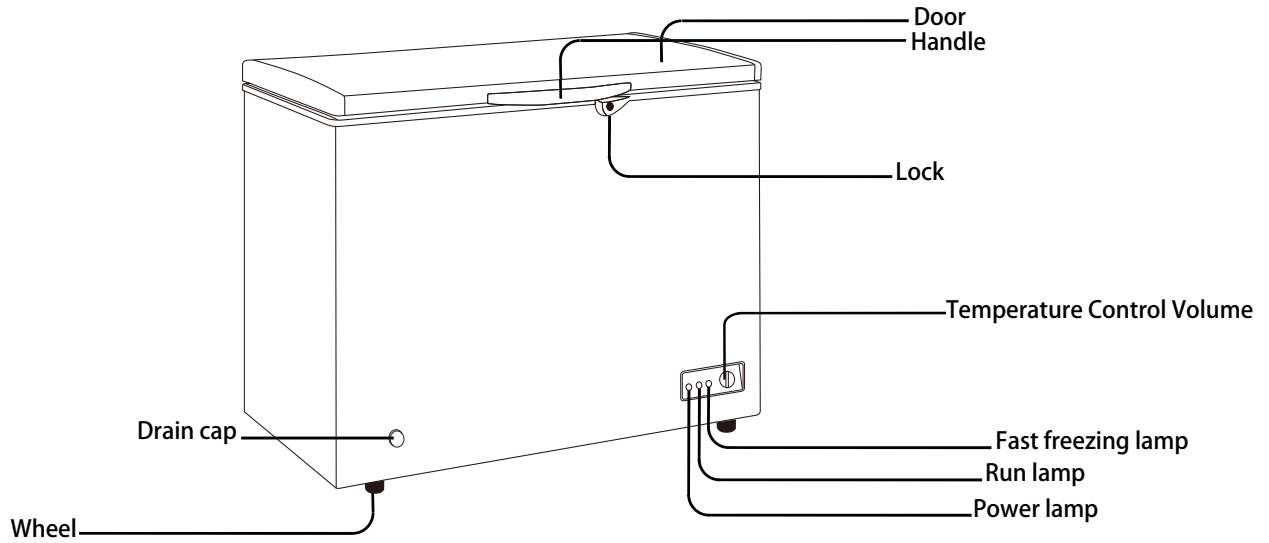

Model	LED Lamp	Handle	Key	Basket
SJC118	1	1	1	1
SJC128	1	1	1	1
SJC168	1	1	1	1
SJC178	1	1	1	1
SJC218	1	1	1	1
SJC228	1	1	1	1
SJC318	1	1	1	2
SJC328	1	1	1	2
SJC518	2	2	2	3
SJC528	2	2	2	3

PART NAMES AND FUNCTIONS

FAST FREEZING

Once press the button and the light will be ON, then the freezer will be in the state of Fast Freezing.
Once finished, please turn OFF the button otherwise the compressor will keep running and the food will be damaged.



Never touch the interior of the freezer chamber or frozen foods in the compartment with wet hands as this could result in frostbite.



Keep the key out of reach of children and not in the vicinity of the freezer.

TEMPERATURE ADJUSTMENT

- To adjust the temperature inside the freezer/cooling compartment, use the control dial on front-bottom side of the chest freezer. Normally use chest freezer with temperature MID.
- If the cooling performance is inadequate, turn the temperature control dial in the direction of MAX. If too cold, turn dial in direction of MIN.

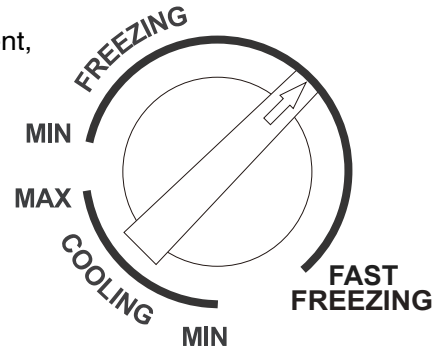

SPECIFICATIONS

Model	Rated Voltage/Frequency	Dimensions(mm)(W x H x D)
SJC118	220-240V/50Hz	574 x 564 x 845
SJC168	220-240V/50Hz	754 x 564 x 845
SJC218	220-240V/50Hz	950 x 564 x 845
SJC318	220-240V/50Hz	1116 x 664 x 845
SJC518	220-240V/50Hz	1535 x 740 x 825

Model	Rated Voltage/Frequency	Dimensions(mm)(W x H x D)
SJC128	220-240V/50Hz	574 x 564 x 845
SJC178	220-240V/50Hz	754 x 564 x 845
SJC228	220-240V/50Hz	950 x 564 x 845
SJC328	220-240V/50Hz	1116 x 644 x 845
SJC528	220-240V/50Hz	1535 x 740 x 825



The above image is for reference only, configuration is subject to actual product.

SHARP
SHARP CORPORATION

L08060913-C