

# SHARP®

MODEL

**LC-50LE275X**

**LC-58LE275X**

**LC-65LE275X**

LED BACKLIGHT TV

LED 背光电视机

OPERATION MANUAL

使用说明书

# AQUOS



**HDMI**

**LED**

**DVB-T2**

**MHL**  
Mobile High-Definition Link

**DOLBY AUDIO™**

ENGLISH

中文





# Dear SHARP customer

Thank you for your purchase of the SHARP LCD colour TV product. To ensure safety and many years of trouble-free operation of your product, please read the Important Safety Precautions carefully before using this product.

## Contents

	Page		Page
<b>Dear SHARP customer</b> .....	<b>1</b>	Picture menu.....	7
<b>Supplied accessories</b> .....	<b>1</b>	Audio menu.....	7
<b>Important Safety Precautions</b> .....	<b>1</b>	ECO menu.....	7
<b>Trademarks</b> .....	<b>2</b>	Setup menu.....	7
<b>Quick Reference</b> .....	<b>2</b>	Option menu.....	9
Attaching the stand.....	2	<b>Direct Button Operation</b> .....	<b>10</b>
<b>Preparation</b> .....	<b>3</b>	Programme Guide.....	10
Antenna connection.....	3	Info.....	10
Connecting external devices.....	3	ATV/DTV/RADIO buttons.....	10
<b>Part names and functions</b> .....	<b>4</b>	Switching the analogue audio format.....	10
Remote control unit.....	4	EPG.....	11
TV (Front).....	4	Colour adjustment and still image.....	11
TV (Rear).....	5	ECO mode.....	11
<b>Watching TV</b> .....	<b>5</b>	<b>Using a Smartphone with the TV</b> .....	<b>12</b>
Turning the TV on/off.....	5	<b>Teletext function</b> .....	<b>12</b>
Initial auto installation.....	5	<b>USB Media Player</b> .....	<b>12</b>
Checking Signal information.....	5	<b>Appendix</b> .....	<b>14</b>
Auto installation.....	5	<b>Specifications</b> .....	<b>14</b>
Programme setup.....	6	<b>Dimensional drawings</b> .....	<b>15</b>
<b>On-Screen Display Menu</b> .....	<b>6</b>	<b>CLEARING THE PASSWORD</b> .....	<b>16</b>
Selecting a preset AV mode.....	6		
Menu operation.....	7		

### NOTE

- The illustration and on-screen displays in this operation manual are for explanation purposes and may vary slightly from the actual operation.
- Some features differ depending on the selected country.

## Supplied accessories

Remote control unit



"AAA" size battery (x 2)

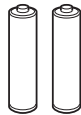

Operation manual



Stand unit



Stand assembly



Screws (x 4)

## Important Safety Precautions

- Stand base must be attached to prevent the TV set from falling down and cause injuries.
- Cleaning — Unplug the AC cord from the AC outlet before cleaning the product. Use a soft damp cloth to clean the product. Do not use liquid cleaners, aerosol cleaners or chemical cloth to clean it, as such materials may damage the product.
- Water and moisture — Do not use the product near water, such as bathtub, washbasin, kitchen sink, laundry tub, swimming pool and in a wet basement.
- Do not place vases or any other water-filled containers on this product. The water may spill onto the product causing fire or electric shock.
- Stand — Do not place the product on an unstable cart, stand, tripod or table. Doing so can cause the product to fall, resulting in serious personal injuries as well as damage to the product. Use only a cart, stand, tripod, bracket or table recommended by the manufacturer or sold with the product. When mounting the product on a wall, be sure to follow the manufacturer's instructions. Use only the mounting hardware recommended by the manufacturer.
- When relocating the product placed on a cart, it must be moved with utmost care. Sudden stops, excessive force and uneven floor surface can cause the product to fall from the cart.
- Ventilation — The vents and other openings in the cabinet are designed for ventilation. Do not cover or block these vents and openings since insufficient ventilation can cause overheating and/or shorten the life of the product. Do not place the product on a bed, sofa, rug or other similar surface, since they can block ventilation openings. This product is not designed for built-in installation; do not place the product in an enclosed place such as a bookcase or rack, unless proper ventilation is provided or the manufacturer's instructions are followed.
- The LCD panel used in this product is made of glass. Therefore, it can break when the product is struck forcefully or with a sharp object. If the LCD panel is broken, be careful not to be injured by broken glass.
- Heat sources — Keep the product away from heat sources such as radiators, heaters, stoves and other heat-generating products (including amplifiers).
- To prevent fire, never place any type of candle or naked flames on the top or near the TV set.
- To prevent fire or shock hazard, do not place the AC power cord under the TV set or other heavy items.
- Do not place heavy objects on this product or stand on it. Doing so could cause injury if the product overturns. Take special care near children and pets.
- The LCD panel is a very high technology product with 2,073,600 pixels, giving you fine picture details. Due to the very large number of pixels, occasionally a few non-active pixels may appear on the screen as a fixed point of blue, green or red. This is within product specifications and does not constitute a fault.
- **Precautions when transporting the TV**  
When transporting the TV, never carry it by holding or otherwise putting pressure onto the display. Be sure to always carry the TV by two people holding it with two hands — one hand on each side of the TV.
- Do not display a still picture for a long time, as this could cause an afterimage to remain.
- Install the product on the place where the AC cord can be unplugged easily from the AC outlet or from the AC INPUT terminal on the rear of the product.
- If a television is not positioned in a sufficiently stable location, it can be potentially hazardous due to falling. Many injuries, particularly to children, can be avoided by taking simple precautions such as:
  - Using cabinets or stands recommended by the manufacturer of the television.
  - Only using furniture that can safely support the television.
  - Ensuring the television is not overhanging the edge of the supporting furniture.
  - Not placing the television on tall furniture (for example, cupboards or bookcases) without anchoring both the furniture and the television to a suitable support.
  - Not standing the televisions on cloth or other materials placed between the television and supporting furniture.
  - Educating children about the dangers of climbing on furniture to reach the television or its controls.
- Do not install the TV in a location in which it will be subject to water drops such as underneath an air conditioning unit or in the vicinity of a humidifier.
  - Water drops falling onto the TV and water entering inside it may result in fire, electric shock, or malfunctions.
  - We recommend that you install the TV at least 1 m away from the outlet of an air conditioner.

## Trademarks

- The terms HDMI and HDMI High-Definition Multimedia Interface, and the HDMI Logo are trademarks or registered trademarks of HDMI Licensing, LLC in the United States and other countries.
- Manufactured under license from Dolby Laboratories. Dolby, Dolby Audio, and the double-D symbol are trademarks of Dolby Laboratories.
- MHL, the MHL Logo, and Mobile High-Definition Link are trademarks or registered trademarks of MHL, LLC in the United States and other countries.

## Quick Reference

### Attaching the stand

- Before attaching (or detaching) the stand, unplug the AC cord from the AC outlet.
- Before performing work spread cushioning over the base area to lay the TV on. This will prevent it from being damaged.

- 1 Confirm the screws supplied with the TV.

Screws (×4)



- 2 Insert the stand assembly into the openings on the bottom of the TV. (①)

- 3 Insert and tighten the screws into the holes on the rear of the TV. (②)

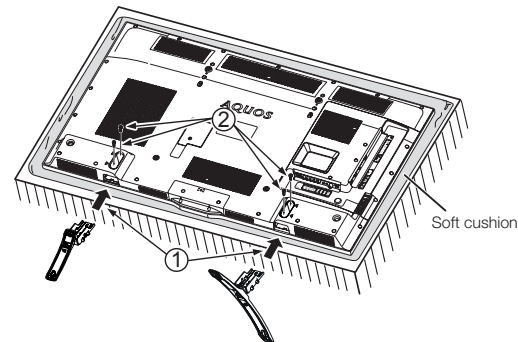

#### NOTE

- To detach the stand, perform the steps in reverse order.

#### CAUTION

- Do not attach or detach the stand without holding it.  
Doing so can cause the stand to fall, resulting in serious personal injuries as well as damage to the stand.

- The illustrations used throughout this manual are based on LC-50LE275X.

# Preparation

## Antenna connection

Connect antenna cable to the antenna terminal

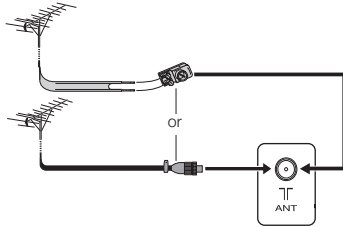

If your outdoor antenna uses a 75-ohm coaxial cable with a standard DIN45325 plug (IEC 169-2), plug it into the antenna jack at the rear of the set.

If your outdoor antenna uses a 300-ohm twin-lead flat feeder, connect a 300-ohm to 75-ohm impedance converter and plug it into the antenna jack at the rear of the set.

### CAUTION

- TO PREVENT RISK OF ELECTRIC SHOCK, DO NOT TOUCH UN-INSULATED PARTS OF ANY CABLES WITH THE AC CORD CONNECTED.

### NOTE

- Place the TV close to the AC outlet, and keep the power plug within reach.

## Connecting external devices

You can connect many types of external equipment to your TV, like a VCR, game console, camcorder, DVD player, Digital TV STB (Set Top Box) and PC. To view external source images, select the input source from **INPUT** on the remote control unit or **INPUT** on the TV.

### CAUTION

- To protect all equipment, always turn off the TV before connecting to a VCR, game console, camcorder, DVD player, Digital TV STB (Set Top Box), PC or other external equipment.
- Refer to the relevant operation manual (VCR, DVD player, etc.) carefully before making connections.

### Connecting a VCR, game console or camcorder

A VCR, game console, camcorder and some other audiovisual equipment can be conveniently connected using the INPUT 3 terminal.

When using component cable (commercially available)

When using composite cable (commercially available)

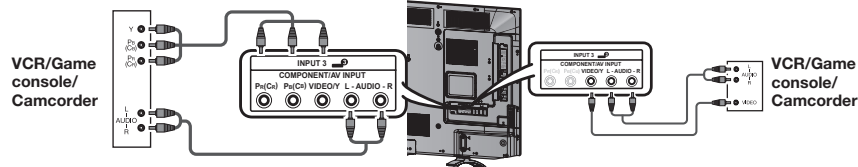

### Connecting a DVD player/Digital TV STB (Set Top Box)

You can use the INPUT 1 (HDMI/ARC)/INPUT 2 (HDMI/MHL) or INPUT 3 terminals when connecting to a DVD player/Digital TV STB (Set Top Box) and other audiovisual equipment.

When using HDMI-certified cable (commercially available)

When using component cable (commercially available)

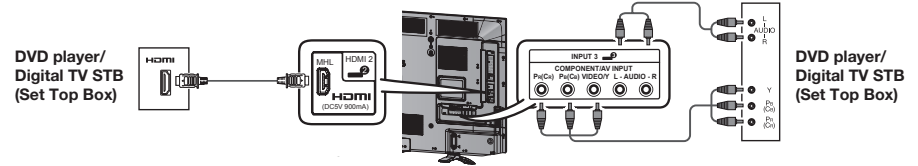

### Connecting a PC

You can use the INPUT 1 (HDMI/ARC)/INPUT 2 (HDMI/MHL) terminal when connecting to a PC.

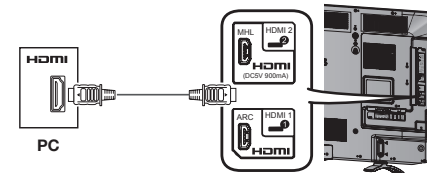

### Connecting a USB device

Connect a USB device to the TV.

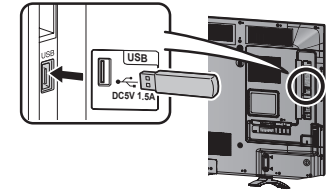

### CAUTION

- Do not disconnect a USB device from the TV while transferring files, when a screen is in "USB" mode.

### Using Digital Audio Output

It is possible to output audio through the DIGITAL AUDIO OUTPUT terminal. PCM audio outputs from the terminal.

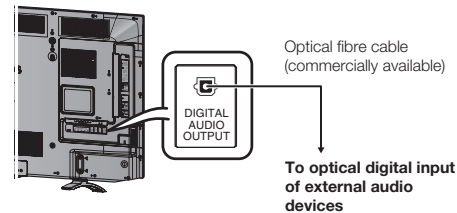

### NOTE

- The DIGITAL AUDIO OUTPUT terminal usually outputs the same audio from the speakers. (The audio of the content you are viewing is output from the terminal.)
- The DIGITAL AUDIO OUTPUT terminal does not output some signals, depending on devices and software.

• The illustrations used throughout this manual are based on LC-50LE275X.

## Remote control unit

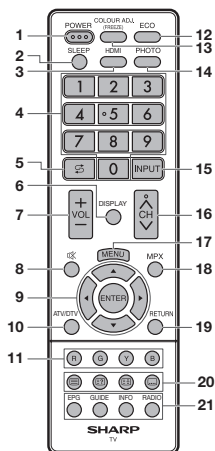

- 1 POWER (STANDBY/ON)**  
To switch the power on and off. (See page 5.)
- 2 SLEEP**  
Set the Sleep timer.  
0 hr. 30 min. → 1 hr. 00 min. → 1 hr. 30 min.  
Off ← 2 hr. 30 min. ← 2 hr. 00 min.
- 3 HDMI**  
Select the HDMI input mode.
- 4 0 - 9**  
Set the channel.  
TELETEXT mode: Set the page. (See page 12.)
- 5 Flashback**  
Press to return to the previous selected channel or external input mode.
- 6 DISPLAY**  
Display the channel or input information.
- 7 VOL + / VOL -**  
Set the volume.  
(VOL +) Increase the volume.  
(VOL -) Decrease the volume.
- 8 Mute**  
Press → Mutes sound.  
Press again → Restores sound.  
Mute will be cancelled after 30 minutes. However, the TV will not suddenly output loud sound as the volume level will be set to 0 automatically. Increase the volume level by pressing **VOL +**.

- 9 ▲/▼/◀/▶ (Cursor)**  
Select a desired item on the setting screen.  
**ENTER**  
Execute a command.
- 10 ATV/DTV**  
Press to access analogue and digital TV mode. (See page 10.)
- 11 Colour (Red/Green/Yellow/Blue)**  
The coloured buttons are correspondingly used to select the coloured items on the screen.  
TELETEXT mode: Select a page. (See page 12.)
- 12 ECO**  
Reduce overall power consumption based on user preferences. (See page 11.)
- 13 COLOUR ADJ. (FREEZE)**  
Freeze a motion picture on the screen and adjust the colour tone of the still image. (See page 11.)
- 14 PHOTO**  
Display your pictures directly on the TV screen. (See page 12.)
- 15 INPUT (INPUT SOURCE)**  
Select an input source.
- 16 CH ^ / CH v**  
TV input mode: Select the channel.  
(CH ^) Increase the channel number.  
(CH v) Decrease the channel number.  
TELETEXT mode: Select a page. (See page 12.)
- 17 MENU**  
Display the menu screen.
- 18 MPX**  
Select the sound multiplex mode.
- 19 RETURN**  
MENU mode: Return to the previous menu screen.
- 20 (TELETEXT), (Reveal hidden for TELETEXT), (Hold), (SUBTITLE for TELETEXT)**  
Use for TELETEXT mode. (See page 12.)
- 21 EPG**  
DTV mode: To display EPG (Electronic Programme Guide) screen. (See page 11.)  
**GUIDE**  
DTV mode: Display the programme channel list. (See page 10.)  
**INFO**  
DTV mode: Display the programme information. (See page 10.)  
**RADIO**  
Press to access RADIO mode. (See page 10.)

## Inserting the batteries

Before using the TV for the first time, insert two "AAA" size batteries (supplied). When the batteries become depleted and the remote control fails to operate, replace the batteries with new "AAA" size batteries.

- 1** Open the battery cover.
- 2** Insert the two supplied "AAA" size batteries.
- 3** Close the battery cover.

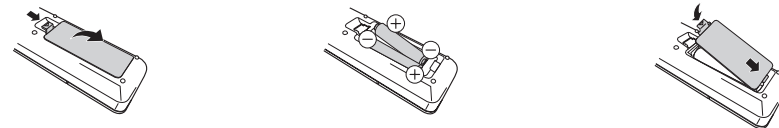

- Place batteries with their terminals corresponding to the (+) and (-) indications in the battery compartment.

## CAUTION

- Batteries (battery pack or batteries installed) shall not be exposed to excessive heat such as sunshine, fire or the like.

## TV (Front)

### LC-50LE275X

### LC-58LE275X

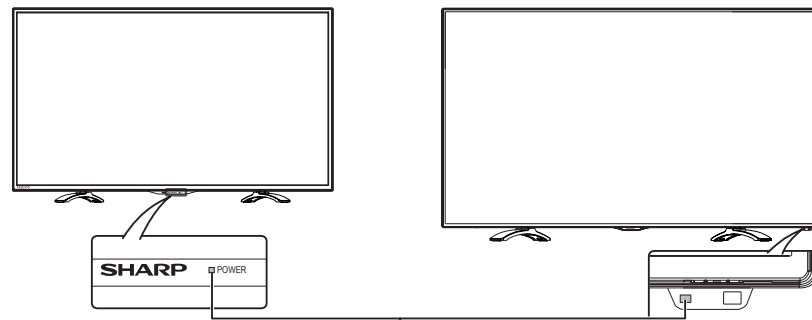

#### POWER indicator

Light off	Power off.
Lighted (Red)	The TV is in standby mode.
Lighted (Green)	The TV is on.

- The illustrations used throughout this manual are based on LC-50LE275X.

## TV (Rear)

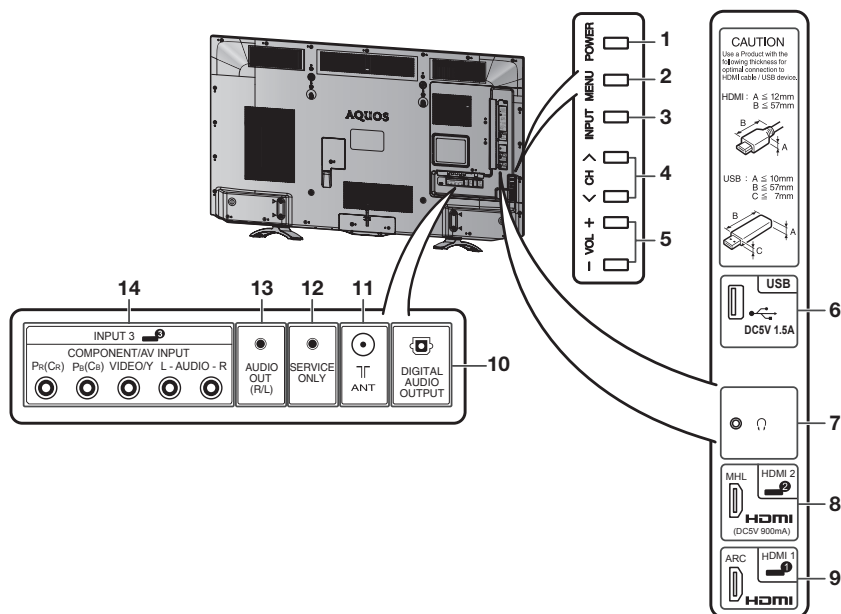

- 1 **POWER** (On/Off) button
- 2 **MENU** button
- 3 **INPUT** button
- 4 Channel up (▲)/down (▼) buttons
- 5 Volume up (+)/down (-) buttons
- 6 USB terminal
- 7 Headphone jack (  $\phi$  3.5 mm)
  - The speakers do not output volume when headphones are plugged in.
- 8 INPUT 2 (HDMI/MHL) terminal
- 9 INPUT 1 (HDMI/ARC) terminal
- 10 DIGITAL AUDIO OUTPUT terminal
- 11 Antenna input terminal
- 12 SERVICE ONLY terminal\*
- 13 AUDIO OUT terminal
- 14 INPUT 3 terminals

\* Usually do not connect anything to this terminal as it is reserved only for service personnel.

- The illustrations in this operation manual are for explanation purposes and may vary slightly from the actual operations.
- The illustrations used throughout this manual are based on LC-50LE275X.

## Watching TV

### Turning the TV on/off

#### Turning on/off the power

- **To turn on the power**  
Press **POWER** on the TV. (After a few seconds, an image appears with sound.)
- **To turn off the power**  
Switch it off by pressing **POWER** on the TV.

#### Standby mode

- **To standby mode**  
If the TV is switched on, you can switch it to standby by pressing **POWER** on the remote control.
- **Switching on from standby**  
From standby, press **POWER** on the remote control.

#### NOTE

- If you are not going to use this TV for a long period of time, be sure to remove the AC cord from the AC outlet.
- Minor power is consumed when the unit is in standby mode.

### Initial auto installation

When the TV powers on for the first time after purchase, the initial auto installation wizard appears. Follow the menu and make the necessary settings one after another.

- 1 Press **POWER** on the TV.
    - The initial auto installation wizard appears.
  - 2 Press ▲/▼ to select your country channels listed on the screen, and then press **ENTER**.  
Press ▲/▼ to select the desired language, and then press **ENTER**.  
Press ▲/▼ to select "HOME" or "STORE", and then press **ENTER**.
 

**HOME:**

    - "STANDARD" will be the default value for the "AV mode" setting.

**STORE:**

    - "DYNAMIC (FIXED)" will be the default value for the "AV mode" setting. If the "AV mode" is changed, the TV will automatically switch back to "DYNAMIC (FIXED)" when there is no further change to TV setting for 30 minutes.
    - The confirmation screen appears only when selecting "STORE". Press ▲/▼ to select "Yes" or "No".
    - To change the STORE mode to HOME mode, please refer to page 9 to reset the unit.
- \* Press ▲/▼ to select "DTV", "ATV" or "DTV + ATV", and then press **ENTER**.
- Auto installation will be executed.
  - You do not need to do anything during the auto search.
  - If you select "Others" country, some of DTV channel may not tune properly.

### Checking Signal information

If you install a DVB-T/DVB-T2 antenna for the first time or relocate it, you should adjust the alignment of the antenna to receive a good reception while checking the antenna setup screen.

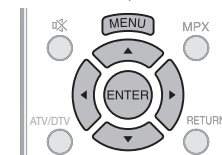

- 1 Press **MENU** and the MENU screen displays.
- 2 Press ◀ to select "Programme setup".
- 3 Press ▲/▼ to select "Digital setting", and then press **ENTER**.
- 4 Press ▲/▼ to select "Signal information", and then press **ENTER**.
  - The "Signal information" screen will appear.

### Auto installation

You can run auto installation again, even after setting up the preset channels.

- 1 Press **MENU** and the MENU screen displays.
- 2 Press ◀ to select "Programme setup".
- 3 Press ▲/▼ to select "Auto installation", and then press **ENTER**.  
If you have already set the password, enter it here.
  - See page 7 for setting a password.
- 4 Press ▲/▼ to select your country channels listed on the screen, and then press **ENTER**.  
Press ▲/▼ to select the desired language, and then press **ENTER**.
  - \* Press ▲/▼ to select "DTV", "ATV" or "DTV + ATV", and then press **ENTER**.

You do not need to do anything during the auto search. Press **MENU** to exit.

#### \* NOTE

- In the setting of some country, selecting of "DTV", "ATV" or "DTV + ATV" may not be shown.
- A region or service selection screen may display depending on the country settings or cable providers selections. Follow the screen prompts to make the selections.

## Programme setup

### Digital setting

You can reconfigure DTV services settings automatically or manually.

- 1 Press **MENU** and the MENU screen displays.
- 2 Press **◀▶** to select "Programme setup".
- 3 Press **▲/▼** to select "Digital setting", and then press **ENTER**. If you have already set the password, enter it here.
  - See page 7 for setting a password.
- 4 Press **▲/▼** to select the desired menu item, and then press **ENTER**.

### Auto search

Use this menu to add new services automatically after auto installation has been completed.

#### NOTE

- A region or service selection screen may display depending on the country settings or cable providers selections. Follow the screen prompts to make the selections.

### Manual search

Add new services within a specified frequency band.

- Press **◀▶** to select the frequency and then press **ENTER**.

### Analogue setting

You can reconfigure the TV channel settings automatically or manually using **Auto search** or **Manual adjust**.

### Auto search

You can also automatically search by performing the procedure below. This is the same function as programme auto search in auto installation.

- 1 Press **MENU** and the MENU screen displays.
- 2 Press **◀▶** to select "Programme setup".
- 3 Press **▲/▼** to select "Analogue setting", and then press **ENTER**. If you have already set the password, enter it here.
  - See page 7 for setting a password.
- 4 Press **▲/▼** to select "Auto search", and then press **ENTER**.  
You do not need to do anything during the auto search. Press **MENU** to exit.

### Manual adjust

You can set some channel items manually.

- 1 Repeat steps 1 to 3 in **Auto search**.
- 2 Press **▲/▼** to select "Manual adjust", and then press **ENTER**.
- 3 Press **▲/▼** to select your desired item, and then press **◀▶** to adjust the settings.

Item	Description
<b>Storage to [1-99]</b>	Save programme to your desired channel number. Press <b>R</b> to save.
<b>Sound system</b>	Select the optimum sound system (Broadcasting system) to receive. (B/G, D/K, I, M)
<b>Colour system</b>	Select the optimum colour system to receive. (PAL, SECAM, NTSC)
<b>Current CH</b>	Select the channel you want to edit. <ul style="list-style-type: none"> <li>• Selected channel will be automatically reflected in the background.</li> </ul>
<b>Search</b>	Start searching from current channel. <ul style="list-style-type: none"> <li>• Instead of pressing <b>◀▶</b> to adjust the frequency, you can set by directly entering the frequency number of the channel with <b>0-9</b>. Press <b>R</b> to save.</li> </ul>
<b>Fine-tune</b>	Tune the frequency of the stored channel to your desired position. <ul style="list-style-type: none"> <li>• Adjust while checking the background picture as a reference. Press <b>R</b> to save.</li> </ul>

#### NOTE

- The frequency shown below the On-Screen Display shows the real-time frequency of the displayed channel.

## Programme edit

Use this menu to set up a channel individually.

- 1 Repeat steps 1 to 3 in **Auto search**.
- 2 Press **▲/▼** to select "Programme edit", and then press **ENTER**.
- 3 Press **▲/▼** to select the channel you want to edit, and then press **1 to 5** on the remote control if necessary or press **RETURN** to exit.
  - As you toggle down the channels, each channel is immediately reflected in the background when you press **ENTER**.

#### 1 (Erase programme)

Channels can be erased individually. Press **1** to erase the selected channel.

#### 2 (Label)

You can change channel names individually. Maximum 5 alphanumeric can be input. Press **2** to start labelling. Press **▲/▼/◀▶** to select a character, and then press **2** again or **ENTER** to save.

#### 3 (Sort)

Channel positions can be sorted freely. Press **3** to select the channel you want to move. Press **▲/▼** to move it to the desired position, and then press **3** again or **ENTER** to save.

#### 4 (Skip)

Channels with "Skip" set to "On" are passed over when using **CH/▲/▼** even if selected while watching the image from the TV. Press **4** to skip the selected channel. Press **4** again to cancel the skip.

#### 5 (Lock)

You can block the viewing of any selected channel. Password must be set first to allow "**🔒**" to function.
 

- See page 7 for setting a password.

 Press **5** to lock the selected channel. Press **5** again to unlock the locked channel.

## On-Screen Display Menu

### Selecting a preset AV mode

"AV mode" gives you several viewing options to choose from to best match the system environment, which can vary due to factors like room-brightness, type of programme watched or the type of image input from external equipment.

- 1 Press **MENU** and the MENU screen displays.
- 2 Press **◀▶** to select "Picture" and "Audio".
- 3 Press **▲/▼** to select "AV mode", and then press **ENTER**.

Selected item	Description
<b>STANDARD</b>	For a highly defined image in a normally bright room.
<b>MOVIE</b>	For a movie.
<b>PC</b>	For PC (Available only when inputting an HDMI).
<b>DYNAMIC</b>	For a clear-cut image emphasising high contrast for sports viewing.
<b>DYNAMIC (FIXED)</b>	Changes the image and sound settings to the factory preset values. No adjustments are allowed.

#### NOTE

- You can select a different AV mode item for each input mode. (For example, select STANDARD for TV input and DYNAMIC for VIDEO input.)



## Menu operation

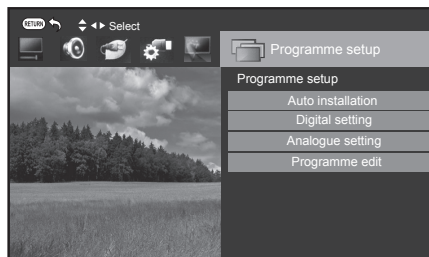

- 1 Press **MENU** and the MENU screen displays.
- 2 Press **◀/▶** to select the desired menu. (Programme setup, Picture, Audio, ECO, Setup, Option)
- 3 Press **▲/▼** to select the desired menu item. Press **ENTER** to proceed if necessary.
- 4 Press **▲/▼** or **◀/▶** to select the desired item or adjust the item to the desired level. Press **ENTER** if necessary.
- 5 Press **RETURN** as necessary to return to the previous MENU. Press **MENU** to exit the MENU.

## Picture menu

### Picture adjust

#### Adjustment items

Selected item	◀ button	▶ button
<b>Backlight</b>	The screen dims	The screen brightens
<b>Contrast</b>	For less contrast	For more contrast
<b>Brightness</b>	For less brightness	For more brightness
<b>Colour</b>	For less colour intensity	For more colour intensity
<b>Tint</b>	Skin tones become reddish	Skin tones become greenish
<b>Sharpness</b>	For less sharpness	For more sharpness

### NOTE

- "Picture adjust" cannot be changed during "DYNAMIC (FIXED)" mode.
- For resetting all "Picture adjust" items to factory preset values, press **▲/▼** to select "Reset", press **ENTER**, press **▲/▼** to select "Yes", and then press **ENTER**.

### DNR (Digital Noise Reduction)

Reduces noise on screen and produces a clearer video image. (Auto, High, Low, Off)

### Wide mode

You can manually select the size of a picture appeared on your screen.

Selectable picture size varies with the type of signal received.

Press **▲/▼** while the wide mode menu displays on the screen.

- As you toggle down the options, each mode is immediately reflected on the TV.

Selected item	Description
<b>Normal</b>	Keeps the original aspect ratio in a full screen display.
<b>Zoom 14:9</b>	For 14:9 letterbox pictures. A thin side bar appears on each side, and you may also see bars on the top and bottom with some programmes.
<b>Panorama</b>	In this mode the picture is progressively stretched toward each side of the screen.
<b>Full</b>	For 16:9 squeeze pictures.
<b>Cinema 16:9</b>	For 16:9 letterbox pictures. Bars may appear on the top and bottom with some programmes.
<b>Cinema 14:9</b>	For 14:9 letterbox pictures. Bars may appear on the top and bottom with some programmes.
<b>Dot by Dot</b>	Displays an image with the same number of pixels on the screen (only when receiving a 1080i/1080p signal).
<b>Underscan</b>	Display with an Underscan image only when receiving a 720p signal. Display with the High-Definition image adjusted optimally. Noise may appear on the edge of the screen with some programmes.
<b>Just scan</b>	Keeps the original aspect ratio and enlarges the picture as much as possible.
<b>Auto</b>	Keeps the original aspect ratio based on source information and enlarge the picture as much as possible.

### NOTE

- Some picture sizes may not be displayable depending on the input signal.
- "Auto" and "Just scan" can be selected only during video playback in "Movie mode" of USB Media Player.

### Eagle View\*

"Eagle View" technology produces a sharp picture from the original moving picture. (On, Off)

### AquoMotion Lite\*

"AquoMotion Lite" technology provides superior solutions for display picture quality removing motion blur. (Advanced, High, Off)

### \* NOTE

- Only for LC-50LE275X and LC-58LE275X.
- This effect is greater on fast moving images.
- This function will have no effect in the following cases.
  - 1) The type of signal received is a PC signal.
  - 2) An OSD is being displayed.
  - 3) Teletext is activated.
- If images appear blurred or flickering, set to "Off".

## Audio menu

### Sound adjust

Selected item	◀ button	▶ button
<b>Treble</b>	For weaker treble	For stronger treble
<b>Bass</b>	For weaker bass	For stronger bass
<b>Balance</b>	Decrease audio from the right speaker	Decrease audio from the left speaker

### Surround

When you set to "On", you can enjoy surround sound, the same as if you were in a movie theatre. (On, Off)

### NOTE

- For resetting all "Sound adjust" items to the factory preset values, press **▲/▼** to select "Reset", press **ENTER**, press **▲/▼** to select "Yes", and then press **ENTER**.

## ECO menu

### No signal off

You can set the TV to automatically power off in about 15 minutes after the TV goes into a state of receiving no programme signals. (Enable, Disable)

- Five minutes before the power shuts down, the remaining time displays every minute.

### NOTE

- When a TV programme finishes, and the TV receives signal input, this function may not operate.

### No operation off

You can set the TV to automatically power off when no TV operation is performed for more than 3 hours. (30 min., 3 hr., Disable)

- Five minutes before the power shuts down, the remaining time displays every minute.

## Setup menu

### Child lock (ATV and DTV input mode only)

Allows you to use a password to protect certain settings from being accidentally changed.

#### Setting a password

- 1 Repeat steps 1 and 2 in **Menu operation**.
- 2 Press **▲/▼** to select "Child lock", and then press **ENTER**.
- 3 If you have already set the password, enter it here.
- 4 Press **▲/▼** to select "Change password", and then press **ENTER**.
- 5 Enter the 4-digit number as a password using **0 - 9**.
- 6 Enter the same 4-digit number as in step 5 to confirm.

### NOTE

- To view a locked channel, you must enter a password. When you select a locked channel, "Child lock has been activated" is displayed.
- Press **ENTER** to display the password input window.

## On-Screen Display Menu

### Clearing the password

Allows you to clear your password.

- 1 Repeat steps 1 to 3 in **Setting a password**.
- 2 Press ▲/▼ to select "Clear password".
- 3 Press ◀/▶ to select "Yes", and then press **ENTER**.

### Parental rating (DTV input mode only)

This function allows TV channels to be restricted. It prevents children from watching violent or sexual scenes that may be considered inappropriate.

- 1 Repeat steps 1 to 3 in **Setting a password**.
- 2 Press ▲/▼ to select "Parental rating", and then press **ENTER**.
- 3 Press ▲/▼ to select your desired rating, and then press **ENTER**.

Selected item	Description
Off	Cancel the blocking.
Age xx years	Select desired age to block. (Example) If age 14 is selected, programmes rated for ages of 15 or more are blocked.

### HDMI auto view (HDMI input mode only)

Selected item	Description
Enable/Disable	Set whether or not to use the Auto Selection of WIDE MODE based on signal recognition received from the HDMI signal.

### Link operation

Using the HDMI CEC (Consumer Electronics Control) protocol, with Link operation you can interactively operate compatible system equipment (e.g. DVD), by connecting the link operation-compatible devices with HDMI-certified cables to the TV. Link operation allows you to operate the HDMI-connected equipment and the TV by using a single remote control unit. (On, Off)

### Audio return channel

If this function is set to "Auto", the TV can send audio data for video content shown on the TV to a connected audio device with just one ARC-compatible cable. Using this function eliminates the need to use a separate digital or analogue audio cable. (Auto, Off)

#### Connection for using "Audio return channel"

You need to use ARC-compatible cables/devices and connect to the INPUT 1 terminal to activate this function.

#### NOTE

- The ARC (Audio Return Channel) function works only when using the INPUT 1 terminal.
- When you use an audio system compatible with the ARC function of the TV, you do not need to connect an optical audio cable to the TV. However you need to make sure "Speaker selection" is "On".

### Auto wide (DTV input mode only)

The "Auto wide" allows the TV to switch automatically among the different picture size. (On, Off)

#### NOTE

- Use "Wide mode" if an image does not switch to the appropriate picture size. When the broadcast signal contains no aspect ratio information, the function will not work even if enabled.

### 4:3 mode (DTV input mode only)

The 4:3 mode allows you to select between "Full" and "Normal".

Selected item	Description
Full	Wide image without side bars.
Normal	Normal range keeping 4:3 or 16:9 aspect ratio.

#### 4:3 screen types

4:3 mode "Full"



4:3 mode "Normal"



### Quick start

You can reduce the TV's start-up time after turning on the power with the remote control unit.

Selected item	Description
On	The TV quickly starts up from standby, more of power consumption is required during standby.
Off	Power consumption is less than 0.6W.

### Language

Select from among 10 languages: English, Simplified Chinese, Arabic, French, Portuguese, Russian, Persian, Thai, Vietnamese and Indonesia.

### Text language

Select from among 5 kinds of language: West Europe, East Europe, Cyrillic, Arabic and Farsi.

#### NOTE

- Teletext can display only when it is sent by a network. Not used to convert between languages.

### Digital setup

#### Selecting the language

Set up to two preferred multi audio languages to display if the audio languages are available.

- 1 Press **MENU** and the MENU screen displays.
- 2 Press ◀/▶ to select "Setup".
- 3 Press ▲/▼ to select "Digital setup", and then press **ENTER**.
- 4 Press ▲/▼ to select "Digital audio language", and then press **ENTER**.
- 5 Press ▲/▼ to select "1st language" or "2nd language".
- 6 Press ◀/▶ to select the desired language.

#### NOTE

- If audio for the selected languages is not included in a received broadcast, audio will not be output for that language.

### Audio description (DTV input mode only)

This function allows you to adjust volume output of audio description if the TV receives a signal including audio description.

- 1 Press **MENU** and the MENU screen displays.
- 2 Press ◀/▶ to select "Setup".
- 3 Press ▲/▼ to select "Digital setup", and then press **ENTER**.
- 4 Press ▲/▼ to select "Audio description", and then press **ENTER**.
- 5 Press ◀/▶ to select the volume.

### Switching the multi audio languages

Each time you press **MPX** on the remote control, the audio language switches.

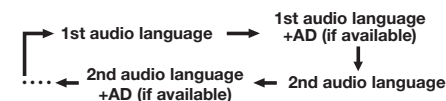

#### NOTE

- This function is valid only if broadcaster is transmitting audio description.

## On-Screen Display Menu

### Displaying subtitles for the hearing impaired

You can display subtitles for the hearing impaired in the Teletext broadcast if the subtitle languages are available.

- 1 Press **MENU** and the MENU screen displays.
- 2 Press **◀▶** to select "Setup".
- 3 Press **▲▼** to select "Digital setup", and then press **ENTER**.
- 4 Press **▲▼** to select "Subtitle", and then press **ENTER**.
- 5 Press **▲▼** to select "1st language" or "2nd language".
- 6 Press **◀▶** to select the desired language.

#### NOTE

- If subtitles for the selected language are not included in a received broadcast, subtitles will not be shown for that language.

### Switching subtitle languages (DVB Subtitle)

Each time you press **⏮** on the remote control, the subtitle switches when the broadcast contains subtitle information.

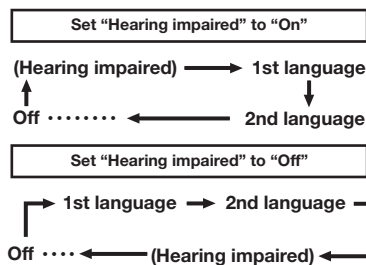

#### NOTE

- This function is valid only if broadcaster is transmitting multilingual subtitles.

### Time zone

This function enables you to select your local time zone.

- 1 Press **MENU** and the MENU screen displays.
- 2 Press **◀▶** to select "Setup".
- 3 Press **▲▼** to select "Digital setup", and then press **ENTER**.
- 4 Press **▲▼** to select "Time zone", and then press **ENTER**.
- 5 Press **◀▶** to select the desired time zone.

#### NOTE

- This function lets you select the right time zone in case the time displayed in the EPG does not match the local time of your area.
- Time zone differ depending on the selected country.

### Identification

You can check the current version of the software on the screen.

### Reset

If complex adjustments are made and the settings cannot be restored to normal, you can reset the settings to the factory preset values.

#### NOTE

- If you execute "Reset", all the settings such as "Picture", "Audio" and "Programme setup" will be reset to the factory preset values.

## Option menu

### Output volume select

Allows you to select what controls the audio output.

Selected item	Description
Fixed	<ul style="list-style-type: none"> <li>• Sound via speakers is adjusted with <b>VOL +/-</b> on the remote control unit or the TV.</li> <li>• Sound via the AUDIO OUT terminal is not adjustable and constantly outputs.</li> </ul>
Variable	<ul style="list-style-type: none"> <li>• Sound via the AUDIO OUT terminal is adjusted with <b>VOL +/-</b> on the remote control unit or the TV.</li> <li>• Sound via speakers is muted.</li> </ul>

#### NOTE

- When "Output volume select" is set to "Variable", all Audio menu item cannot be adjusted.

### Input select

For setting the signal type of external equipment.

Input source	Selectable item
INPUT3	COMPONENT, VIDEO

### Auto volume

Different sound sources, fairly often do not have the same volume level, for example the changing from movie to the advertisements. Auto volume solves this problem and equalises the volume levels. (On, Off)

### Digital audio output

This function allows you to select your favourite audio output system. (PCM, Auto, Off)

### Speaker selection

You can choose to listen to the external amplifier audio only. (On, Off)

#### NOTE

- This function only available when "Link operation" is set to "On".
- You need to use CEC compatible amplifier to control external speaker volume.

### Audio only

When listening to music from a music programme, you can set the display off and enjoy audio only.

Selected item	Description
On	Audio is output without screen image.
Off	Both screen images and audio are output.

#### NOTE

- When you make operations that change the picture on the TV such as by changing the input source, the "Audio only" function is set to "Off".

### Colour system

You can change the colour system to one that is compatible with the image on the screen. (Auto, PAL, SECAM, NTSC 3.58, NTSC 4.43, PAL-60)

#### NOTE

- If "Auto" is selected, colour system for each channel is automatically set. If an image does not display clearly, select another colour system (e.g. PAL, NTSC 4.43).
- "Colour system" is selectable only when inputting a composite signal.

### Demo (store mode only)

When "Store mode" is set to "On", after all the settings are completed, the Feature demo screen is displayed if there is no operation for 30 seconds.

### System data

#### USB data transfer

This function allows you to update the TV to the latest software using a USB device. You must update the software through the USB terminal.

#### Software update (OAD)

- This function is for automatically download the data for the version update software over digital broadcasts when the "OAD setup" is set to "On".
- To download, follow the instructions when the download message appears during a digital broadcast.
- Once the software upgrade is done, the TV will automatically go to standby state with Red LED.

#### OAD scan

- This function is for manually download the data for the version update software over digital broadcasts.

#### CAUTION

- **Do not disconnect the AC cord when the software upgrade is in progress, as this may cause the upgrade to fail. If problem arises ask a qualified service personnel before the software upgrade period expires.**

# Direct Button Operation

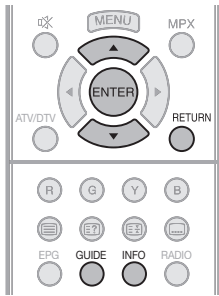

## ATV/DTV/RADIO buttons

Use the following buttons on the remote control to operate the menu.

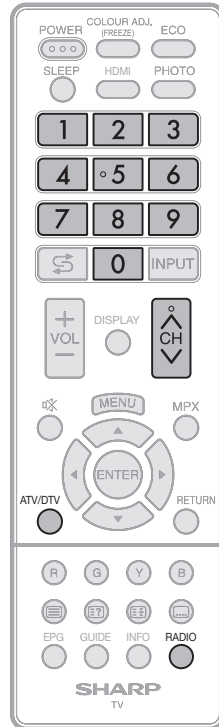

**ATV/DTV:** Press to switch between ATV and DTV mode. After switching from ATV or DTV, radio or external input mode to ATV and DTV mode, the TV jumps to the most recently viewed ATV and DTV channel.

**RADIO:** Press to switch from DTV to radio mode. The TV will jump to the most recently tuned radio channel.

**When you watch the TV for the first time**  
When the TV powers on for the first time after purchase, perform the auto installation.

## Programme Guide

You can check the current channel list of DTV/ATV respectively.

- 1 Press **GUIDE** to display the programme channel list.
- 2 Press **▲/▼** to select your desired programme, and then press **ENTER**.
- 3 Press **RETURN** or **GUIDE** to exit.

## Info

While watching DTV you can check the extended programme information on the screen using **INFO** on the remote control.

### General INFO screen

- Station name
- Title
- Date
- Time for the current programme
- Video system
- Audio system
- Parental rating

### NOTE

- If there is more information, pressing **▲/▼** allows you to go to the next page or return to the previous page.
- You can cancel this info by pressing **INFO**.

## ATV (Analogue TV)

You can run the auto installation to set channels automatically.

- 1 To watch the analogue TV, select "ATV" from "Auto installation" in Programme setup menu. (See page 5.)
- 2 After setting the channels, you can select a channel using **CH▲/▼** or **0-9** on the remote control unit. (See page 4.)

## DTV (Digital TV)

When the TV accesses to DTV mode for the first time, you need to run the auto search. To scan all available services in your area, follow the procedures below.

- 1 To watch the DTV broadcasts, select "DTV" from "Auto installation" in Programme setup menu. (See page 5.)
- 2 After setting the channels, you can select a channel using **CH▲/▼** or **0-9** on the remote control unit. (See page 4.)

## Switching the analogue audio format

You can switch between multiple audio modes when watching a multiple audio or stereo broadcast programme.

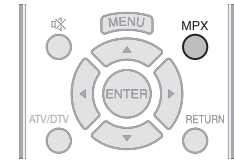

### In the NICAM TV broadcasts

#### When receiving a stereo signal

Each time you press **MPX**, the mode switches between NICAM STEREO and MONO.

#### Stereo mode



#### When receiving a bilingual signal

Each time you press **MPX**, the mode switches among NICAM CH A, NICAM CH B, NICAM CH AB and MONO.

#### Bilingual mode

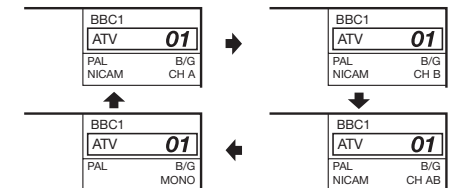

#### When receiving a monaural signal

Each time you press **MPX**, the mode switches between NICAM MONO and MONO.

#### Monaural mode



## Direct Button Operation

### In the TV mode of A2 TV broadcasts

#### When receiving a stereo signal

Each time you press **MPX**, the mode switches between STEREO and MONO.



#### When receiving a bilingual signal

Each time you press **MPX**, the mode switches among CH A, CH B and CH AB.

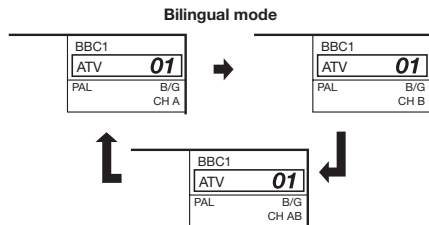

#### When receiving a monaural signal

When you press **MPX**, "MONO" displays.

#### Monaural mode

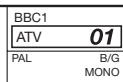

#### NOTE

- "BBC1", "01" and "PAL" are tentative network name, channel and colour system.

## EPG

### What is an EPG?

An "EPG (Electronic Programme Guide)" is a programme schedule, which is displayed on the TV screen. The EPG is broadcasted together with DTV. The TV screen shows the EPG when the viewer presses **EPG** on the remote control, provided that the TV is receiving the digital broadcasting signal. The EPG enables you to search for a programme, do timer view the programme schedule in detail.

### Basic Operation

#### Display the EPG screen

- 1 Press **EPG**.

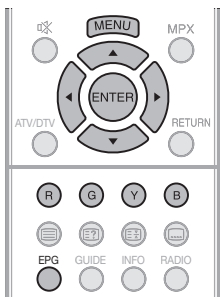

- 2 Press **▲** to select PROGRAMME GUIDE/TIME.
- 3 Press **◀/▶** to select the desired channel/time span.

#### Close the EPG screen

- 4 Press **EPG** again or **RETURN** to exit.

### Reminder timer setting

You can schedule a reminder for future programmes. Channel will automatically change on time as scheduled.

- 1 Press **EPG**.
- 2 Press **▲/▼** to select the programme you want to watch.
- 3 Press **B** to set reminder time.
- 4 Press **ENTER** to save reminder timer.
  - "Timer save success" will display.

#### NOTE

- "Timer overlay" will display if same time is set twice.
- "Timer past" will display if past time is set.

- 5 Press **ENTER** to display the reminder schedule list.
- 6 Press **RETURN** or **EPG** to exit.

### Viewing the reminder schedule list

- 1 Press **EPG**.
- 2 Press **Y** to display the reminder schedule list.
- 3 Press **▲/▼** to display next or previous screen.
- 4 Press **RETURN** or **EPG** to exit.

### Cancelling the reminder timer setting

- 1 Press **EPG**.
- 2 Press **Y** to display the reminder schedule list.
- 3 Press **▲/▼** to select a programme you want to cancel.
- 4 Press **R** to delete a programme from reminder list.
- 5 Press **RETURN** or **EPG** to exit.

## Colour adjustment and still image

Allows you to adjust the colour tone of a still image.

- 1 Press **COLOUR ADJ. (FREEZE)**, the moving image will be captured and colour adjustment screen displays.
- 2 Press **▲/▼/◀/▶** to adjust the colour to your desired setting.

Button	Description
▲	White with greenish tone.
▼	White with reddish tone.
◀	White with bluish tone.
▶	White with yellowish tone.
R	Reveal/hide the setting screen.
G	Set adjustment to last user setting.
B	Close the setting screen and unfreeze image.
ENTER	Save/exit setting.

#### NOTE

- The colour adjustment screen and still image will automatically goes out after 30 minutes.
- Freeze/Colour adjustment function does not work in USB Photo/Movie playback. It works for HDMI and composite/component.

## ECO mode

This function enables you to reduce the backlight brightness in order to decrease the power consumption and increase the backlight life span as shown in the following table.

Selected item	Description
ECO 1	Reduces the backlight brightness.
ECO 2	Reduces the backlight brightness more than "ECO 1".
ECO Off	Normal setting of backlight brightness.

ECO status will be displayed on the channel information window.

## Using a Smartphone with the TV

This function enables you to connect the TV to a smartphone that supports Mobile High-Definition Link (MHL) using an MHL-compatible cable. To connect the TV to your MHL-compatible smartphone, be sure to use an MHL-compatible cable (commercially available).

- You can view pictures and video on a large screen.
- You can play back music files.

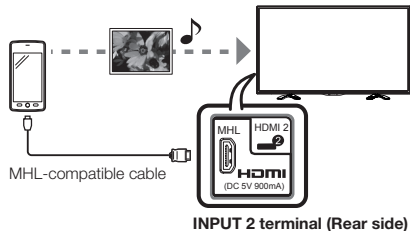

### NOTE

- An MHL-compatible portable device is required to use this function. Connect the device to the INPUT 2 terminal.
- This product incorporates MHL 2.

### Auto power on

When an MHL-compatible device is connected to the TV, the TV turns on automatically.

- This function operates when "Link operation" is set to "On". (See page 8.)

### Auto input selection

When an MHL-compatible device is connected while the TV is on, the input mode is selected automatically.

- This function operates when "Link operation" is set to "On". (See page 8.)

### Operation using the remote control

The remote control of the TV can be used to operate a portable device.

- **▲/▼/◀/▶, ENTER, 0-9**, etc.
- The operations vary depending on the connected equipment and content being viewed.
- **Colour (Red/Green/Yellow/Blue)** may be available to control play/pause/fast forward/back forward function.

- The illustrations used throughout this manual are based on LC-50LE275X.

## Teletext function

### What is Teletext?

Teletext broadcasts pages of information and entertainment to specially equipped television sets. News, weather reports, sports information, stock exchange prices and programme previews are among the many services available.

### Turning on and off Teletext

- 1 Select a TV channel or external input source providing the Teletext programme.
- 2 Press **TELETEXT** to display the Teletext.
- 3 Each time you press **TELETEXT**, the screen switches as shown below.



### NOTE

- If you select a programme with no Teletext signal, "No Teletext available," is displayed.
- The same message displays during other modes if no Teletext signal is available.

### Button functions

Buttons	Description
<b>CH (▲/▼)</b>	Increase or decrease the page number.
<b>Colour (Red/Green/Yellow/Blue)</b>	You can select a group or block of pages displayed in the coloured brackets at the bottom of the screen by pressing the corresponding <b>Colour (Red/Green/Yellow/Blue)</b> on the remote control unit.
<b>0-9</b>	Directly select any page from 100 to 899 by using <b>0-9</b> .
<b>Ⓡ (Reveal hidden for TELETEXT)</b>	To reveal hidden information such as an answer to a quiz.
<b>Ⓢ (Hold)</b>	To stop updating Teletext pages automatically or release the hold mode.
<b>Ⓜ (Subtitle for TELETEXT)</b>	Display the subtitle during Teletext page. <ul style="list-style-type: none"> <li>• Subtitle will not be displayed when the service does not contain subtitle information.</li> </ul>

### NOTE

- Teletext can display only when it is sent by a network. Not used to convert between languages.

## USB Media Player

### Selecting modes

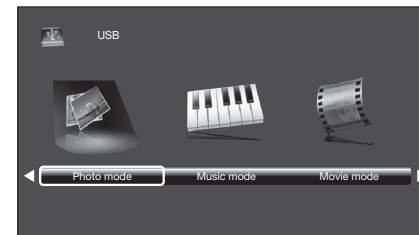

- 1 Press **INPUT** to select the "USB" mode.
- 2 Press **◀/▶** to select "Photo mode", "Music mode" or "Movie mode", and then press **ENTER**.
- 3 Press **◀/▶** to select your USB directory, and then press **ENTER**.
- 4 Press **▲/▼/◀/▶** to select the desired folder, and then press **ENTER**.

### NOTE

- "Wide mode" is fixed during "Photo mode" and "Music mode".
- Depending on the USB device, the TV may not be able to recognise the contained data.
- A file name with more than 10 characters may not be displayed all (depending on the character set).
- Files in USB 1.1 devices may not be played properly.
- Operation using USB hubs is not guaranteed.
- The compatibility of USB HDDs may not be guaranteed.

### PHOTO slideshow



When you press **PHOTO**, the TV screen will automatically play the photo slideshow.

- If there is no USB drive, the TV will switch to **Selecting modes** screen.
- Photo slideshows will autoplay only for the photos located on the top layer of USB drive. To enable autoplay for photos located in a subfolder, you need to manually select the subfolder, and then press **PHOTO**.

You can select the duration for each photo to display, and also the duration for the slideshow to play.

### Duration for photos to display

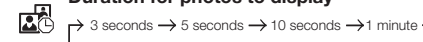

### Duration for slideshow to play

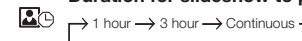

- The TV will automatically power off after the selected playtime ends.

### NOTE

- Background music will autoplay during a slideshow only if the music file is located in the same folder with the photo files.
- If you want to stop the photo slideshows, press **RETURN** to exit.

## USB Media Player

### Control panel for photo/music/movie mode operations

- Press **B** to display the control panel below.

Button/ menu	Description	Photo	Music	Movie
<b>ENTER</b>	When selecting a folder icon: Enter this directory. When selecting a thumbnail: Play the selected file.	✓	✓	✓
	Play/Pause.	✓	✓	✓
	Rewind. Each time you press rewind, the speed will change (2x, 4x, 8x, 16x).	-	✓	✓
	Fast-forward. Each time you press fast-forward, the speed will change (2x, 4x, 8x, 16x).	-	✓	✓
	Play the previous file.	✓	✓	✓
	Play the next file.	✓	✓	✓
<b>RETURN/□</b>	Stop playback and return to the list of files.	✓	✓	✓
	Loop. Each time you press <b>ENTER</b> , the mode will switch between Repeat 1 → Repeat All → Repeat None	✓	✓	✓
	Play/cancel the background music.	✓	-	-
	Mute. Press <b>ENTER</b> to toggle between mute and unmute.	-	✓	-
	Two loop. Press <b>ENTER</b> to set the current playback time starting point. Press <b>ENTER</b> to set the loop end of the current playing time and start loop playback. Press <b>ENTER</b> button to cancel the loop.	-	-	✓
	Show playlists. Select a file from the playlists to start playback.	✓	✓	✓
	Display information about the file.	✓	✓	✓
	Slow-forward. Each time you press slow-forward, the speed will change.	-	-	✓
	Single frame-forward. Each time you press <b>ENTER</b> , the picture will change to the next still picture.	-	-	✓
	Set time for music/movie playback.	-	✓	✓
	Rotate clockwise 90°.	✓	-	-
	Rotate counterclockwise 90°.	✓	-	-
	Zoom in an image. Select to display larger image size.	✓	-	✓
	Zoom out an image. Select to display smaller image size.	✓	-	✓
	Pan image up, down, left or right after you zoom in. Press <b>ENTER</b> to exit.	✓	-	✓
	Select playback length of a slideshow.	✓	-	-
	Select photo display interval.	✓	-	-
	Wide mode. You can manually select the size of a picture appeared on your screen.	-	-	✓

#### NOTE

- Files in folder which are not related to a selected mode cannot be accessed.
- "Unsupported file" alert will pop up for a selected file of invalid format.

### List of files compatible with USB mode

<b>USB device/File system</b>	USB Memory/FAT/FAT32/NTFS
<b>Photo file format</b>	JPEG (.jpg)/PNG/BMP
<b>Music file format (Files may not be playable depending on the bitrate)</b>	MP3 (.mp3) Bitrate: 32 k, 40 k, 48 k, 56 k, 64 k, 80 k, 96 k, 112 k, 128 k, 160 k, 192 k, 224 k, 256 k, 320 kbps Sampling frequency: 32 k, 44.1 k, 48 kHz

Video file format			
File extension	Container	Video	Audio
*.avi	AVI	H.264 MPEG4 Motion Jpeg	Dolby Digital Plus LPCM ADPCM Dolby Digital
*.mkv	MKV	H.264 MPEG4	Dolby Digital Plus MPEG Dolby Digital
*.mp4 *.mov	MP4	H.264 MPEG4	Dolby Digital Plus MPEG Dolby Digital
*.vob	MPEG2 – PS	MPEG2	LPCM Dolby Digital
*.mpg/*.mpeg	MPG MPEG	MPEG2 MPEG1	LPCM MPEG Dolby Digital
*.ts/*.trp/*.tp	TS	H.264 MPEG2	Dolby Digital Plus LPCM MPEG Dolby Digital

## Appendix

### Troubleshooting

The problems described below are not always caused by malfunctions. Check the TV again before having the TV serviced.

Problem	Possible Solution
<ul style="list-style-type: none"> <li>No power.</li> </ul>	<ul style="list-style-type: none"> <li>Check if you pressed <b>POWER</b> on the remote control unit. (See page 5.) If the indicator on the TV lights up red, press <b>POWER</b>.</li> <li>Is the AC cord disconnected?</li> <li>Has the power been turned on? (See page 5.)</li> </ul>
<ul style="list-style-type: none"> <li>Unit cannot be operated.</li> </ul>	<ul style="list-style-type: none"> <li>External influences such as lightning, static electricity, etc., may cause improper operation. In this case, operate the unit after first turning the power off the TV or unplugging the AC cord and re-plugging it in after 1 or 2 minutes.</li> </ul>
<ul style="list-style-type: none"> <li>Remote control unit does not operate.</li> </ul>	<ul style="list-style-type: none"> <li>Is battery inserted with polarity (+, -) aligned? (See page 4.)</li> <li>Is battery worn out? (Replace with new battery.)</li> <li>Are you using it under strong or fluorescent lighting?</li> <li>Is a fluorescent light shining on the remote control sensor?</li> </ul>
<ul style="list-style-type: none"> <li>Picture is cut off.</li> </ul>	<ul style="list-style-type: none"> <li>Are screen mode adjustments such as picture size made correctly? (See page 7.)</li> </ul>
<ul style="list-style-type: none"> <li>Strange colour, light colour, or dark, or colour misalignment.</li> </ul>	<ul style="list-style-type: none"> <li>Adjust the picture tone. (See page 7.)</li> <li>Is the room too bright? The picture may look dark in a room that is too bright.</li> <li>Check the colour system setting. (See pages 6 and 9.)</li> <li>Check the HDMI auto view setting. (See page 8.)</li> </ul>
<ul style="list-style-type: none"> <li>Power is suddenly turned off.</li> </ul>	<ul style="list-style-type: none"> <li>The unit's internal temperature has increased. Remove any objects blocking the vent or clean.</li> <li>Check the ECO setting. (See page 7.)</li> <li>Is the sleep timer set? (See page 4.)</li> </ul>
<ul style="list-style-type: none"> <li>No picture.</li> </ul>	<ul style="list-style-type: none"> <li>Is the connection to external equipment correct? (See page 3.)</li> <li>Is the correct input selected?</li> <li>Is the "Picture adjust" correct? (See page 7.)</li> <li>Is the antenna connected properly? (See page 3.)</li> <li>Is "On" selected in "Audio only"? (See page 9.)</li> </ul>
<ul style="list-style-type: none"> <li>No sound.</li> </ul>	<ul style="list-style-type: none"> <li>Is the volume too low? (See page 4.)</li> <li>Make sure that headphones are not connected.</li> </ul>
<ul style="list-style-type: none"> <li>The TV sometimes makes a cracking sound.</li> </ul>	<ul style="list-style-type: none"> <li>This is not a malfunction. This happens when the cabinet slightly expands and contracts according to changes in temperature. This does not affect the TV's performance.</li> </ul>

### Cautions regarding use in high and low temperature environments

- When the unit is used in a low temperature space (e.g. room, office), the picture may leave trails or appear slightly delayed. This is not a malfunction, and the unit will recover when the temperature returns to normal.
- Do not leave the unit in a hot or cold location. Also, do not leave the unit in a location exposed to direct sunlight or near a heater, as this may cause the cabinet to deform and the LCD panel to malfunction.  
Storage temperature: -20°C to +60°C.

## Specifications

Item	Model	LC-50LE275X	LC-58LE275X	LC-65LE275X
LCD panel		126 cm	146 cm	164 cm
Resolution		2,073,600 pixels (1920 × 1080)		
Video colour system		PAL/SECAM/NTSC 3.58/NTSC 4.43/PAL 60		
TV function	TV-standard	Analogue	PAL: B/G, D/K, I SECAM: B/G, D/K, K/K NTSC: M	
		Digital	DVB-T2	
	Receiving channel	VHF/UHF	44.25—863.25 MHz	
		CATV	S1—S41 ch (including Hyperband)	
	TV-tuning system		Auto Preset 99 ch	
	STEREO/BILINGUAL	NICAM: B/G, I, D/K A2 stereo: B/G MTS: M		
Viewing angles		H : 176° V : 176°		
Audio amplifier/Speakers		10 W × 2 / 5 × 10 cm 2pcs	10 W × 2 / 4 × 12 cm 2pcs	
Terminals	Antenna input	UHF/VHF 75 Ω DIN type		
	INPUT 1 (HDMI/ARC)	HDMI input		
	INPUT 2 (HDMI/MHL)	HDMI input (DC5V 900mA output)		
	INPUT 3	VIDEO in, AUDIO in, COMPONENT in		
	AUDIO OUT	AUDIO out		
	USB	USB (DC5V 1.5A output)		
	DIGITAL AUDIO OUTPUT	Optical Digital Audio Output		
	Headphone	∅ 3.5 mm stereo		
OSD language		English/Simplified Chinese/Arabic/French/Portuguese/Russian/Persian/Thai/Vietnamese/Indonesia		
Power requirement		AC 110 — 240 V, 50/60 Hz		
Power consumption		68 W (0.5 W Standby)	106 W (0.5 W Standby)	179 W (0.6 W Standby)
Dimensions	without stand	1123 (W) × 656 (H) × 82 (D) mm	1300 (W) × 763 (H) × 68 (D) mm	1457 (W) × 847 (H) × 65 (D) mm
	with stand	1123 (W) × 687 (H) × 255 (D) mm	1300 (W) × 793 (H) × 302 (D) mm	1457 (W) × 878 (H) × 335 (D) mm
Weight without stand (with stand)		20 kg (21 kg)	25.5 kg (26.5 kg)	36 kg (37.5 kg)
Operating temperature		0°C — 40°C		

- As a part of policy of continuous improvement, SHARP reserves the right to make design and specification changes for product improvement without prior notice. The performance specification figures indicated are nominal values of production units. There may be some deviations from these values in individual units.
  - Specification may differ depending on the selected country.
- CAUTION**
- Installing the Liquid Crystal Television requires special skill that should only be performed by qualified service personnel. Customers should not attempt to do the work themselves. SHARP bears no responsibility for improper mounting or mounting that results in accident or injury.
  - Carefully read the instructions that come with the bracket before beginning work.



# Dimensional drawings

Unit : mm

LC-50LE275X

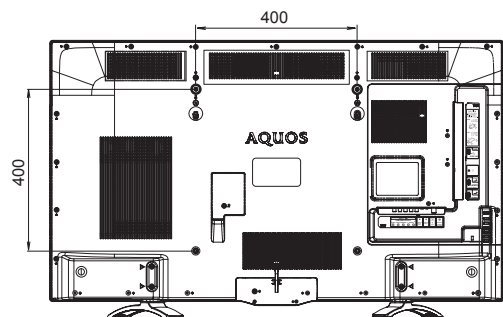
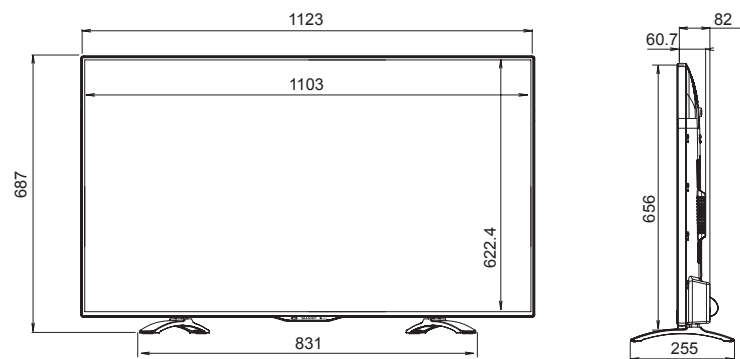

LC-58LE275X

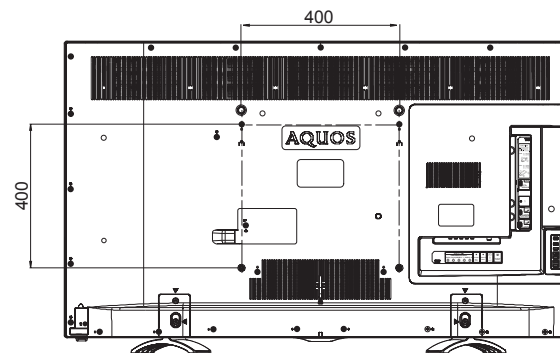
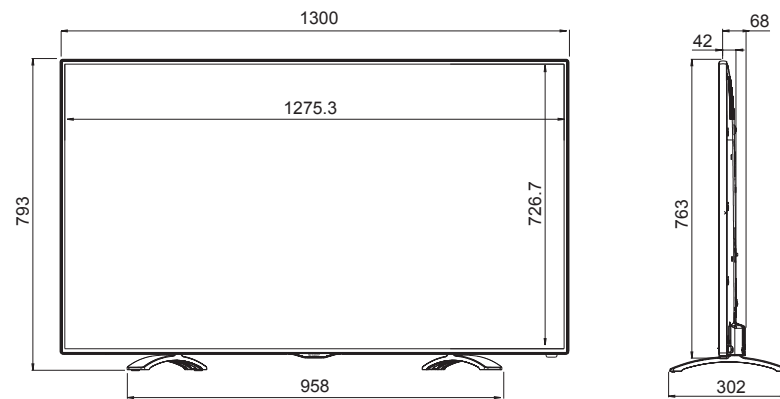

LC-65LE275X

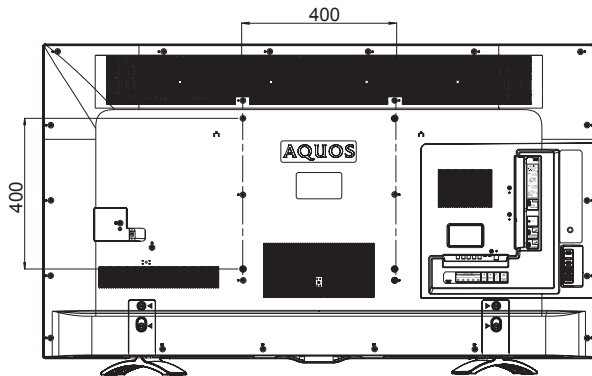
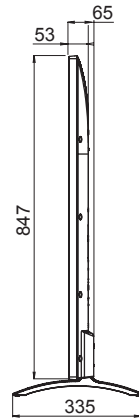
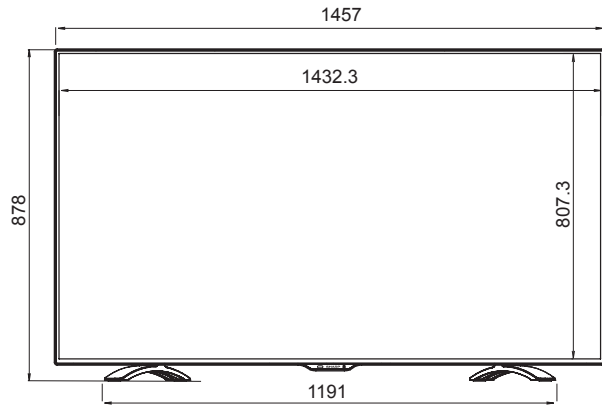

Unit : mm

## CLEARING THE PASSWORD

If you forget the password, clear the password using the following procedure.

- 1 Press **MENU** to display the MENU screen, and then press **◀/▶** to select "Setup".
- 2 Press **▲/▼** to select "Child lock", and then press **ENTER** and the password input screen display.
- 3 If you enter "3001" using **0 - 9**, the "Child lock" setting menu will be displayed.
- 4 Enter the 4-digit number as a password using **0 - 9**. The new password is now set.



The Password is

--	--	--	--

**NOTE**

- As a precautionary measure, make a note of your password above, remove it from this manual, and keep it in a familiar place.

**Note**

---

**Note**

---

**SHARP**<sup>®</sup>  
SHARP CORPORATION

Printed in Malaysia  
马来西亚印刷  
TINS-G446WJZZ  
15P05-MA-NP